



# **OPERATING INSTRUCTIONS**

**FSD1274E5**

**Index 002**



## **Congratulations!**

You have chosen tried and tested Tyrolit Hydrostress equipment that sets technological standards for the industry. Only genuine Tyrolit Hydrostress spare parts guarantee quality and problem-free replacement. If maintenance work is neglected or not performed correctly, we cannot cover our warranty obligations. All repairs must only be performed by trained specialist personnel.

Our Customer Service is at your disposal to help keep your Tyrolit Hydrostress equipment in perfect condition.

We wish you smooth, trouble-free working.

## **Tyrolit Hydrostress**

Copyright © Tyrolit Hydrostress

Tyrolit Hydrostress AG  
Witzbergstrasse 18  
CH-8330 Pfäffikon  
Switzerland  
Phone 0041 (0) 44 952 18 18  
Fax 0041 (0) 44 952 18 00

**[www.tyrolit.com](http://www.tyrolit.com)**

# Contents

<b>1. Safety</b>	<b>5</b>
1.1. General safety information	5
1.2. Signs on the equipment	6
1.3. What to do in an emergency	6
1.4. Intended use	7
1.5. Improper use or misuse	7
1.6. Electrics	7
<b>2. Design and function</b>	<b>8</b>
2.1. Design	8
2.2. Function	10
<b>3. Mounting/Removing</b>	<b>12</b>
3.1. Mounting the saw blade	12
3.2. Water connection	14
3.3. Battery	16
3.4. Cut indicator	17
3.5. Handle adjustment	18
3.6. Light	19
3.7. Fuel	19
<b>4. Operation</b>	<b>20</b>
4.1. Overview of controls	20
4.2. Cutting data table	21
4.3. Control panel	22
4.4. Starting the floor saw	34
4.5. Controlling the travel motion	34
4.6. Lifting and lowering the blade	36
4.7. Shifting gears with the 3-speed transmission	37
4.8. Switching off the floor saw (engine)	38
4.9. After work	38
<b>5. Servicing and maintenance</b>	<b>39</b>
5.1. Tools for maintenance	41
5.2. Preparations for maintenance	41
5.3. Cleaning	41
5.4. Lubrication	42
5.5. Hydraulic system	43
5.6. Belts	43
5.7. Blowing out water	44
5.8. Recycling waste materials	44

---

<b>6. Troubleshooting</b>	<b>45</b>
6.1. Troubleshooting table	45
<b>7. Transport/Storage</b>	<b>48</b>
7.1. Transport	48
7.2. Storage	48
<b>8. Technical data</b>	<b>49</b>
8.1. Dimensions	49
8.2. Dimensions and weights	50
8.3. Engine	50
8.4. Recommended ambient temperature	50
8.5. Lifting drive	51
8.6. Drive	51
8.7. Sound level and vibrations	51
8.8. Battery	51
8.9. Saw blade and blade guard	52
8.10. Water	52
8.11. Fluids and lubricants	52
<b>9. EC Declaration of Conformity</b>	<b>53</b>

# 1 Safety

## 1.1 General safety information



### INFORMATION

This instruction manual is just part of the documentation for the floor saw. These instructions are only complete together with the "Floor Saw Safety Manual/System Description" and the engine documentation.

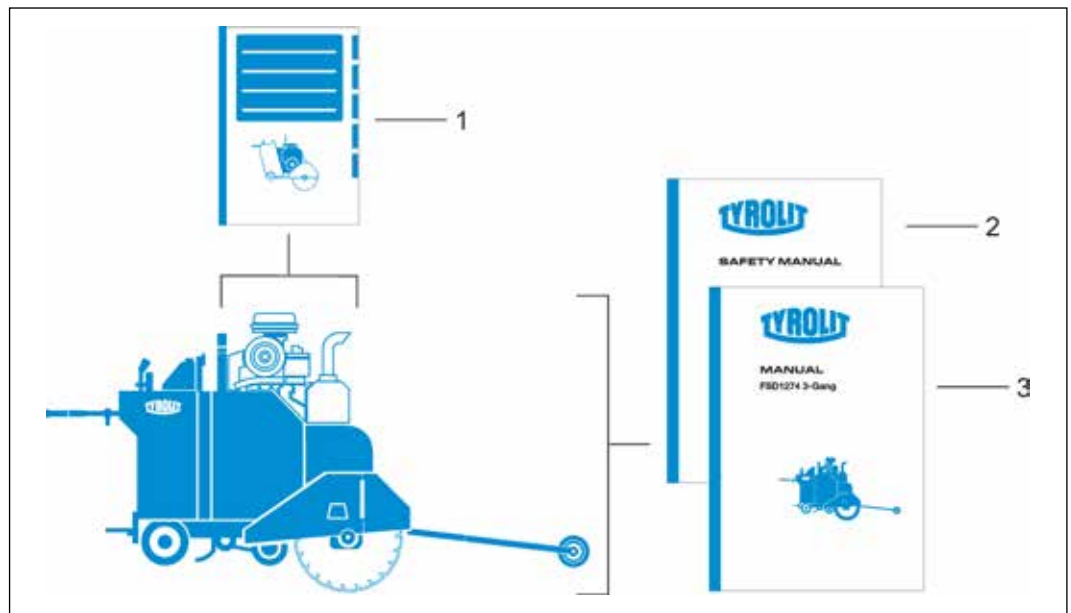

#### Documentation

- 1 Engine documentation
- 2 Floor Saw Safety Manual/System Description
- 3 Floor Saw Operating Instructions



### DANGER

Failure to observe the safety instructions in the "Safety Manual/System Manual" and the operating instructions/engine documentation may result in death or serious injury.

- ▶ Ensure that all documentation has been read and understood.



### DANGER

Risk of cut injuries due to saw blade!

- ▶ Protective gloves must be worn when working on with the floor saw, especially the saw blade.
- ▶ Operate the floor saw only with the blade guard.



### DANGER

Death or serious injury if the machine starts up unexpectedly!

- ▶ Before switching on the floor saw, make sure that there are no persons in the danger zones.
- ▶ Switch off the floor saw when leaving and secure so it cannot be switched back on.



### DANGER

Death or serious injury if the floor saw continues running in the event of an accident.

- ▶ Make sure that the EMERGENCY STOP button can be reached quickly.

## 1.2 Signs on the equipment

### Type plate and danger stickers



#### INFORMATION

Besides the type plate, danger and information stickers are affixed to the floor saw. Follow the instructions to avoid damage and injury.

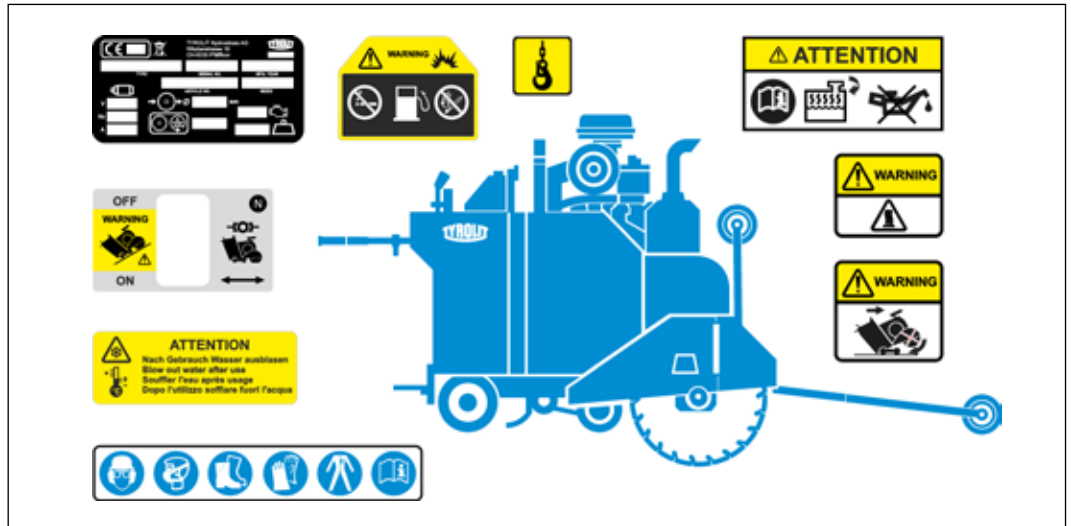

Type plate and danger stickers

## 1.3 What to do in an emergency

- ▶ Press the EMERGENCY STOP button.

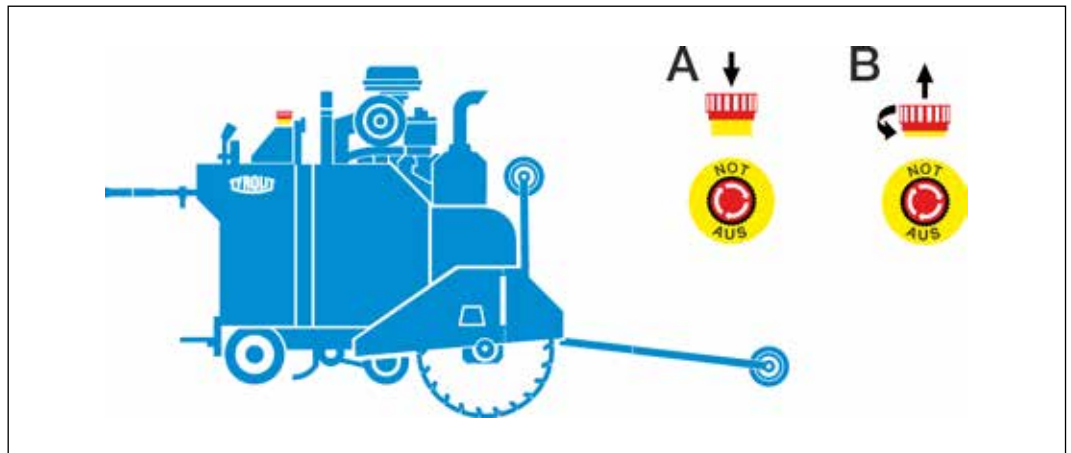

What to do in an emergency

- A Activate EMERGENCY STOP
- B Deactivate EMERGENCY STOP

## 1.4 Intended use

The floor saw has been designed and built for the following use:

- Cutting asphalt and concrete (including reinforced concrete).
- Making plunge cuts, flush cuts and cutting joints in floors.
- Only use tools with an original hole pattern.
- If floor saws are operated in enclosed or underfloor spaces, exhaust fumes from combustion engines must be vented to the outdoors.
- Binding operating limits and characteristic data can be found in the technical data in the operating instructions.

## 1.5 Improper use or misuse

- Use that is not in accordance with the intended use is considered improper use or misuse.
- Since improper use and misuse can in some cases result in considerable hazards, we would like to point out here the improper uses or misuses known to us.

**The following types of use are prohibited:**

- Cutting metal, wood and plastic
- Cutting loose parts (including in concrete)
- Operation in water and in explosion-proof spaces
- Cutting without system and tool cooling (unless dry cutting with a special diamond tool)
- Cutting without the protection devices provided
- Incorrect or no disposal of waste water (saw sludge water)
- Cutting without the protection devices provided

## 1.6 Electrics



### Caution

**Defective electrotechnical equipment is a fire risk.**

- ▶ The electrotechnical equipment must be checked before each use and sporadically during longer periods of use. Defective parts such as cables and plugs must be replaced immediately by persons trained in electrical engineering when in a de-energized state.
- ▶ Check all fuses if switches or controls are not functioning properly. If fuses trip frequently, determine the cause and repair them immediately.

Failure to observe this instruction may result in consequential damage such as fire.



### INFORMATION

You can find electric circuit diagrams in the spare parts list.

## 2 Design and function

### 2.1 Design

#### 2.1.1 Components

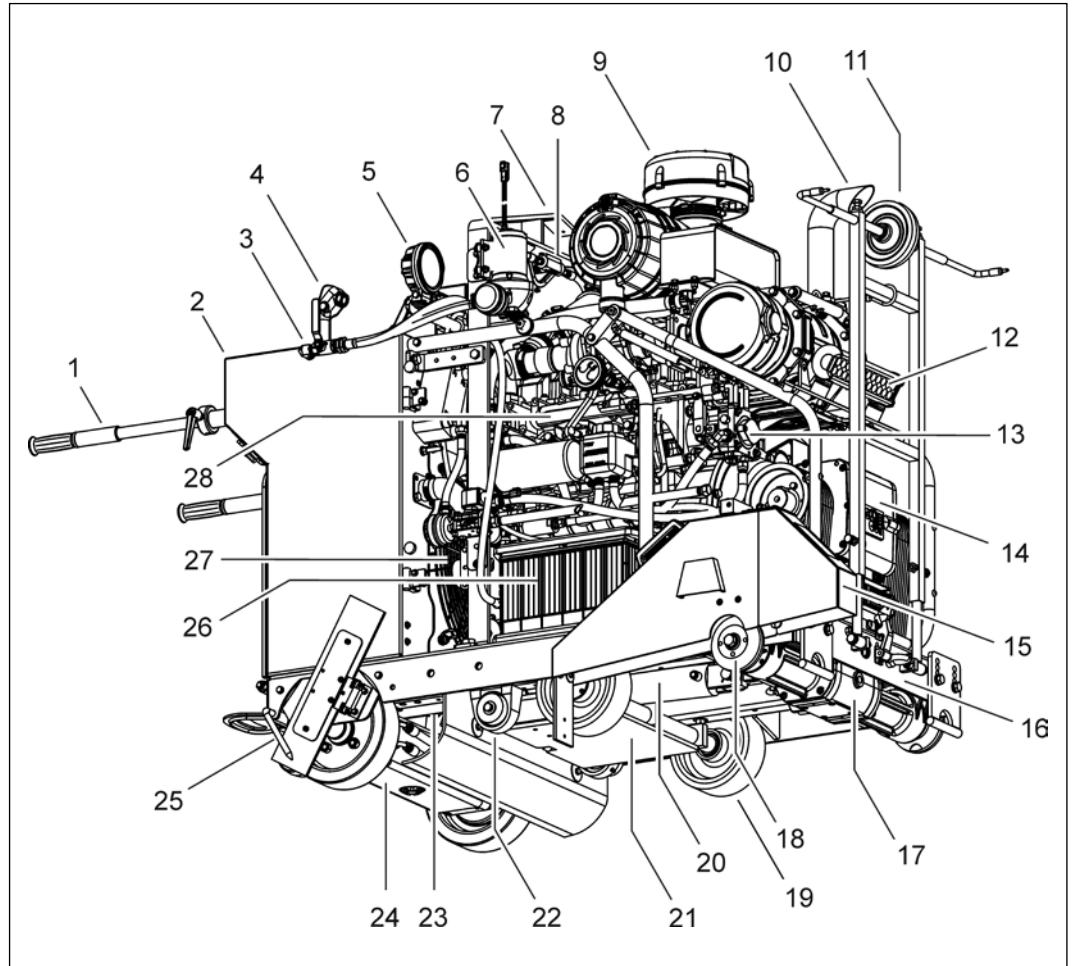

#### Components

1	Handle	11	Cut indicator roll	21	Lifting chassis
2	Control switch/lever	12	Lamp	22	Lifting chassis bearing
3	Tap	13	Hydrostat	23	Splash guard
4	Speed lever	14	Saw blade drive transmission	24	Rear axle
5	Light	15	Blade guard	25	Rear cut indicator
6	Water pump	16	Chassis	26	Battery
7	Crane hitch	17	Saw blade drive	27	Radiator fan
8	Coolant hose	18	Saw blade flange	28	Engine
9	Air filter/pre-separator	19	Wheels		
10	Exhaust	20	Lifting cylinder		



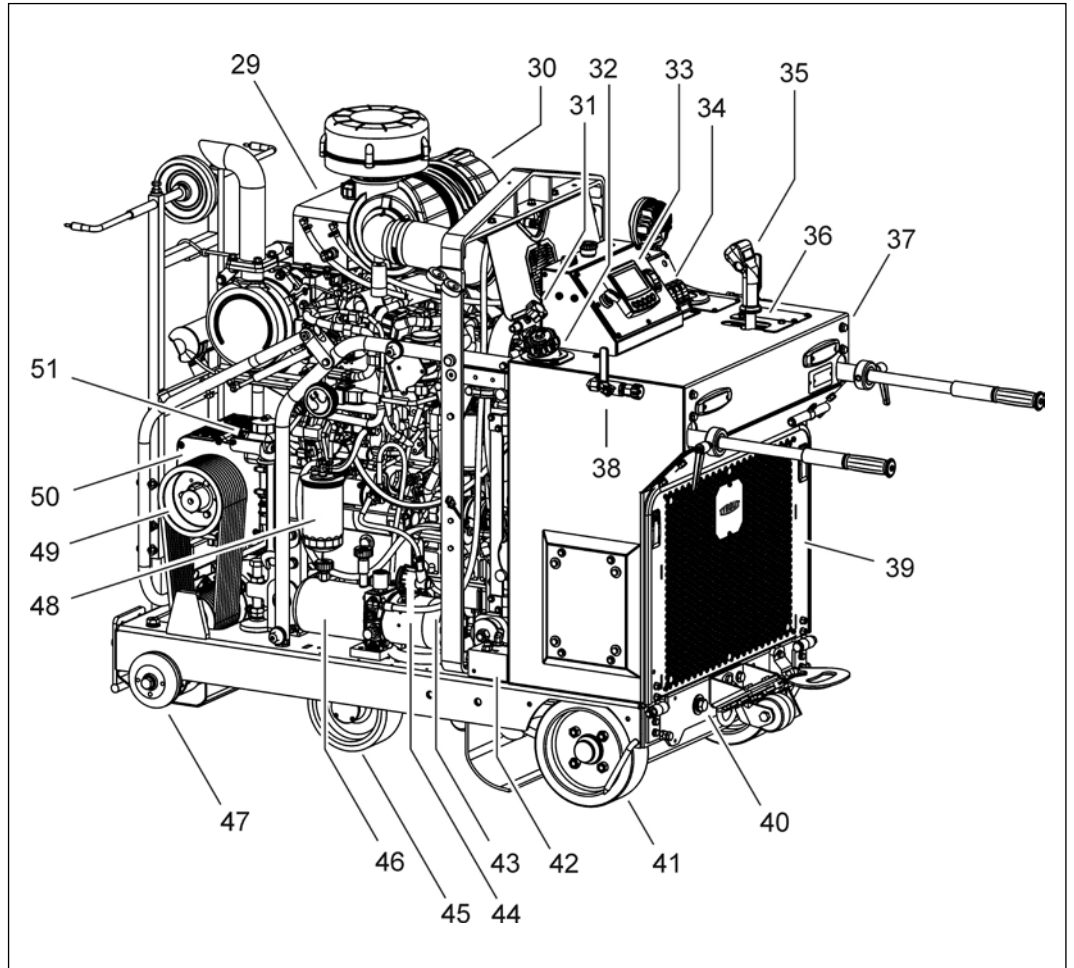

Components

- |    |                        |    |                                 |    |                              |
|----|------------------------|----|---------------------------------|----|------------------------------|
| 29 | Coolant expansion tank | 39 | Radiator                        | 49 | Belt drive                   |
| 30 | Air filter             | 40 | Wheel alignment device          | 50 | Saw blade drive transmission |
| 31 | Light clamp handle     | 41 | Drive wheel                     | 51 | Oil tank for saw blade drive |
| 32 | Tank filler neck       | 42 | Drive valve block               |    |                              |
| 33 | Control panel          | 43 | Pump motor                      |    |                              |
| 34 | Control switch         | 44 | Lifting cylinder hydraulic pump |    |                              |
| 35 | Combination wrench     | 45 | Wheel                           |    |                              |
| 36 | Speed lever            | 46 | Oil tank                        |    |                              |
| 37 | Frame                  | 47 | Saw blade flange                |    |                              |
| 38 | Water connection       | 48 | Diesel filter                   |    |                              |

## 2.2 Function

### 2.2.1 Saw blade drive

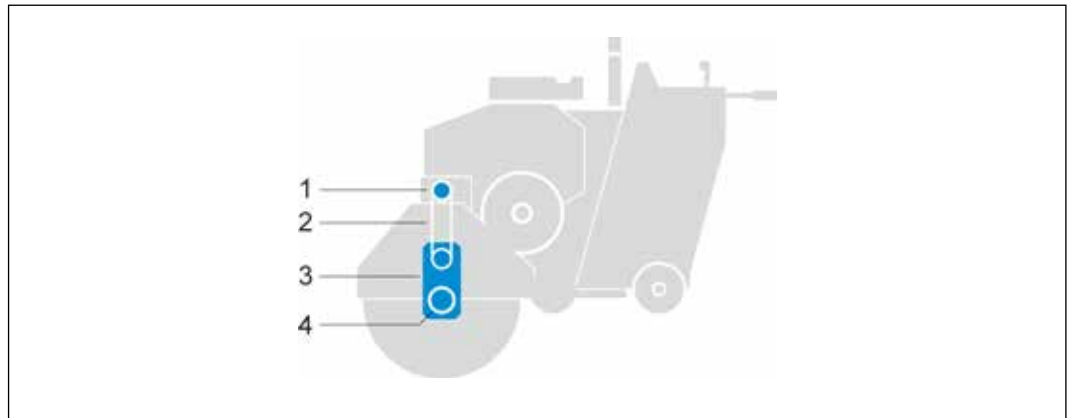

Saw blade drive (diagram)

- |                                |                     |
|--------------------------------|---------------------|
| 1 3-speed (angle) transmission | 3 Blade drive       |
| 2 Driving belt                 | 4 Saw blade spindle |

### 2.2.2 Lifting drive



#### INFORMATION

The lifting movement is achieved by means of a hydraulic cylinder.

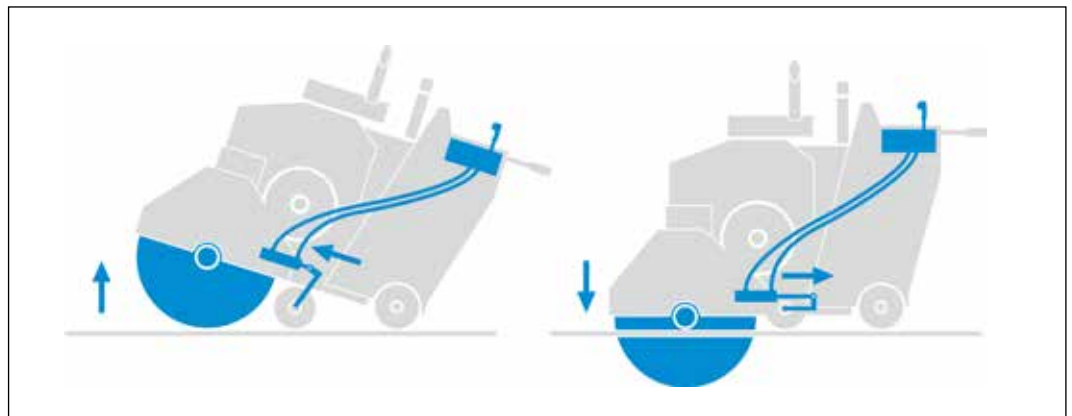

Lifting drive (diagram)

### 2.2.3 Reducing the saw blade speed



#### INFORMATION

The valve sets the stroke speed of the saw blade.



Reducing the saw blade speed (diagram)

### 2.2.4 Drive

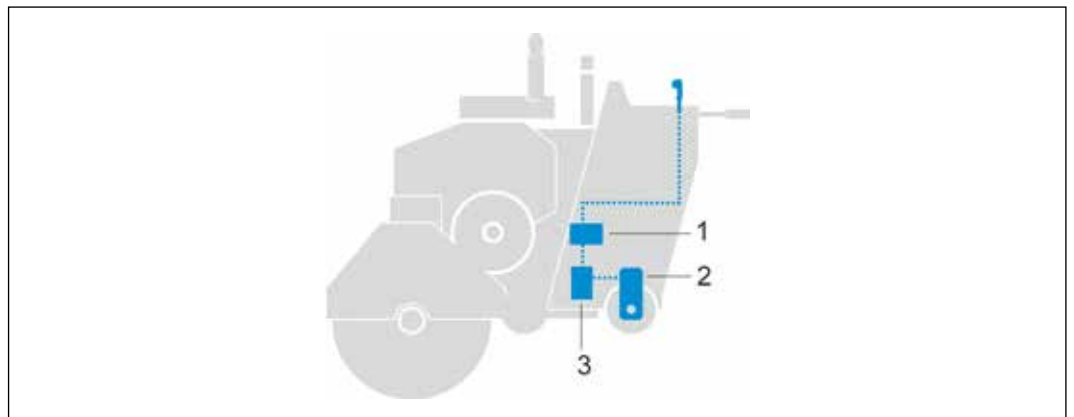

Drive (diagram)

- |                    |               |
|--------------------|---------------|
| 1 Oil pump         | 3 Valve block |
| 2 Hydraulic motors | Drive ON/OFF  |

## 3 Mounting/Removing

### 3.1 Mounting the saw blade



**DANGER**

**Death or serious injury if the saw blade flies off!**

- ▶ Only use genuine screws from Tyrolit Hydrostress AG.



**DANGER**

**Serious injury if the saw blade starts up suddenly!**

- ▶ Switch off the floor saw before working on the saw blade.



**INFORMATION**

Diamond saw blades with mounting holes dia. 25.4 mm can be mounted on the floor saw. Always use a blade guard that is suitable for the blade size.

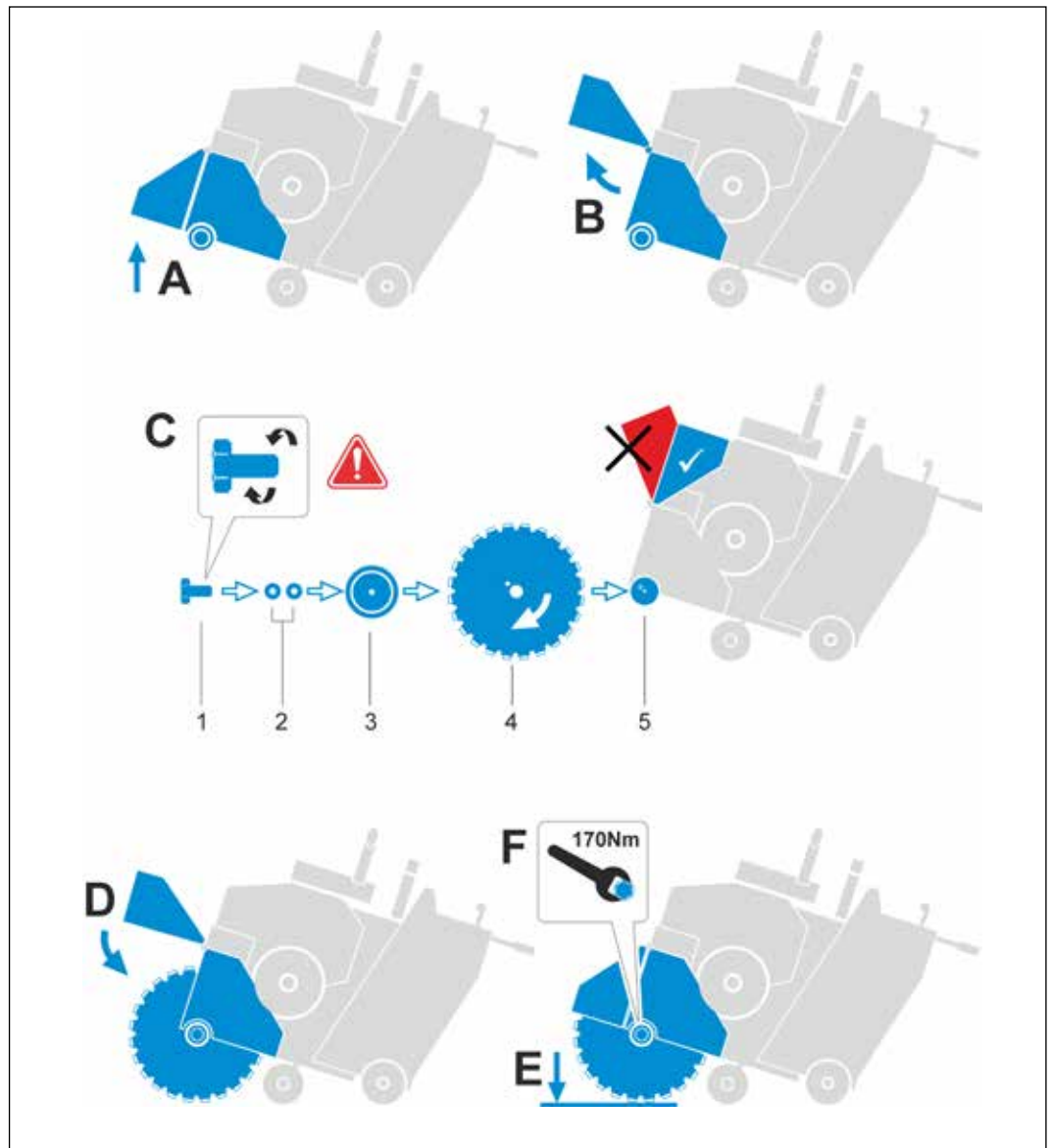

Mounting the saw blade

Proceed as follows:

- ✓ Check that the direction of rotation arrow on the saw blade (C4) matches the direction of rotation of the engine (arrow on the blade guard).
  - ✓ When mounting the saw blade on the right-hand side, use the fastening screw (C1) with left-hand thread. When mounting the saw blade on the left-hand side, use the fastening screw (C1) with right-hand thread
- ▶ Swing the saw blade spindle up (A).
  - ▶ Lift the front protective flap up 180° and secure it (B) with a locking pin.



#### INFORMATION

Using the correct saw blade (size and type) protects the saw blade and improves efficiency, resulting in lower costs.

- ▶ Saw blade inspection
  - Inspect each saw blade before installation and discard damaged saw blades. Inspect the saw blade for:
    - Cracks, notches and dents
    - Damaged/deformed mandrel (centre hole)
    - Darkness/discoloration near the diamond segments
    - Deformation of the saw blade circumference
    - Segment loss/cracks
    - Worn core
    - Bending
    - Sides of unequal width



#### INFORMATION

Spanner

A 15/16-inch combination wrench, located on the right-hand side of the control panel, is provided for mounting and removing the saw blade.

- ▶ Secure the saw blade C4 to the locating flange C5 using blade cover C3 and genuine Tyrolit bolts C1/lock washers C2.
- ▶ Swing the front protective flap down and secure it (B).
- ▶ Carefully place the saw blade on the floor (E) to prevent the saw blade from rotating while you are tightening the bolt.
- ▶ Tighten the blade cover bolts to a torque of 170 Nm (F).
- ▶ Securing the blade flange guard

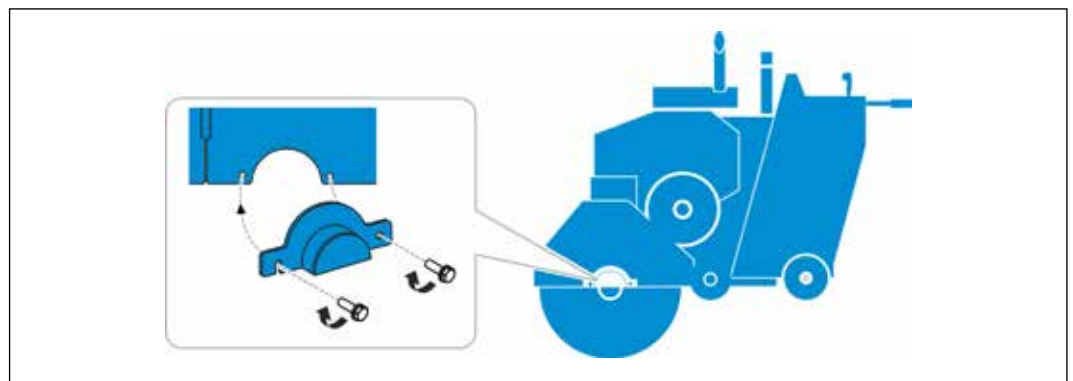

Securing the blade flange guard

## 3.2 Water connection

### 3.2.1 Wet and dry cutting



#### INFORMATION

The floor saw can be used for wet and dry cutting.



#### INFORMATION

Special Tyrolit diamond tools must be used for dry cutting.

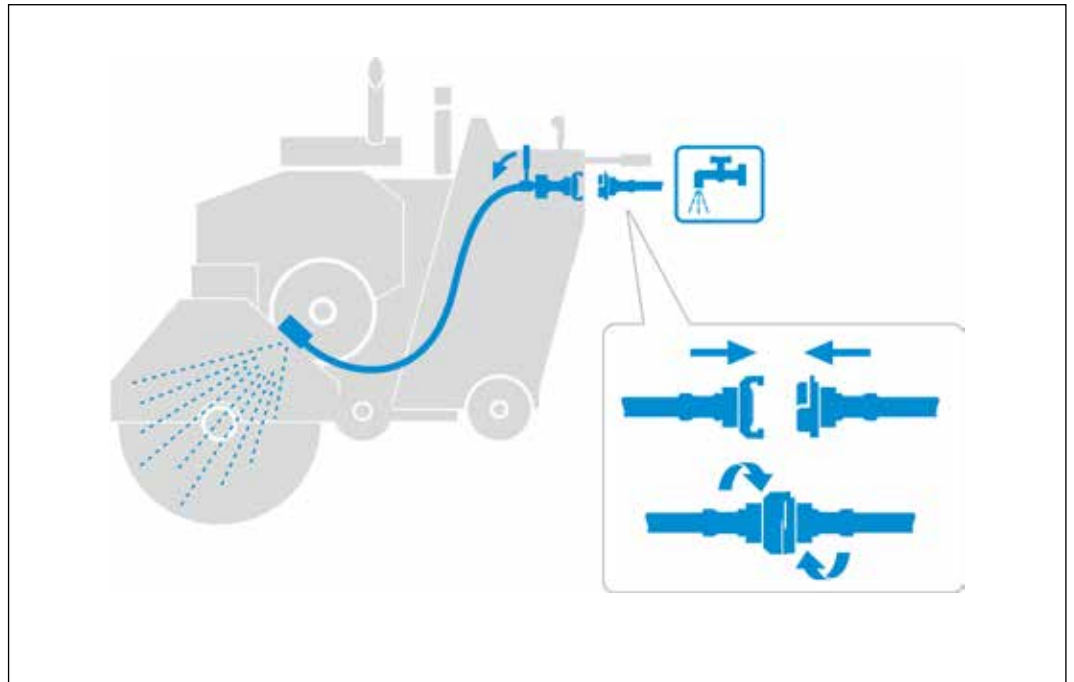

Water connection (diagram)

### 3.2.2 Water supply

The water supply reduces dust during cutting and cools the fuel, transmission and saw blade.



#### INFORMATION

Always test the water supply for adequate pressure and flow before cutting.

Water connection	
Parameter	Value
Pressure	min. 2 bar/max. 6 bar
Flowrate	min. 4 l/min
Max. temperature	25 °C

### 3.2.3 Using the water supply

- ▶ Make sure that the water valves on the right and left-hand sides of the floor saw are closed.
- ▶ Connect the water hose to the water valve on the left-hand side of the floor saw.
- ▶ Check the following supply hose connections to ensure that they are not leaking:
  - Supply hose from right-hand water valve to inlet of fuel cooler assembly.
  - Supply hose from outlet of fuel cooler assembly to inlet of water solenoid valve.
  - Supply hose from outlet of water solenoid valve to transmission inlet.
  - Supply hose from transmission outlet.
- ▶ Connect the water supply hose from the transmission outlet to the water manifold on the blade guard.
- ▶ Move the lever of the water valve on the right-hand side of the floor saw to the fully open position. Increase or reduce the water flow by moving the valve lever on the left-hand side of the floor saw that is connected to the water hose.



#### INFORMATION

You can turn the water on and off and adjust the water flow from either side of the floor saw, as required.

- ▶ When you have finished cutting, turn off the water supply to the blade guard, turn off the water supply at the source, and detach the water source hose from the floor saw.
- ▶ Drain the water from the radiator of the upper transmission.



#### INFORMATION



Pay attention to the engine manufacturer's instructions.

### 3.2.4 Automatic water system (AWS)

The automatic water system has a solenoid valve in the water supply system, which works in conjunction with the "Zero saw blade" option on the control panel. When the saw blade is "zeroed" on the top of the surface, the solenoid valve allows water to flow when the blade is plunged into a cut. When the saw blade is lifted out of the cut and passes the "zero point", the water flow is automatically switched off.



#### INFORMATION

When using AWS, adjust the lever of the water valve so that the water flow is measured. AWS automatically turns the water on/off when the saw blade enters or exits the cut.

### 3.3 Battery



#### **DANGER**

#### **Death or serious injury from the battery!**

Ignitable, explosive gas escapes from the battery. Do not expose the battery to sparks or naked flames, and keep the area around the battery well ventilated.

Disconnect the battery before servicing the floor saw. Always keep the battery cable clamps away from the battery terminals while the battery is disconnected. Take care to always connect the battery cables to the correct terminal when reconnecting.

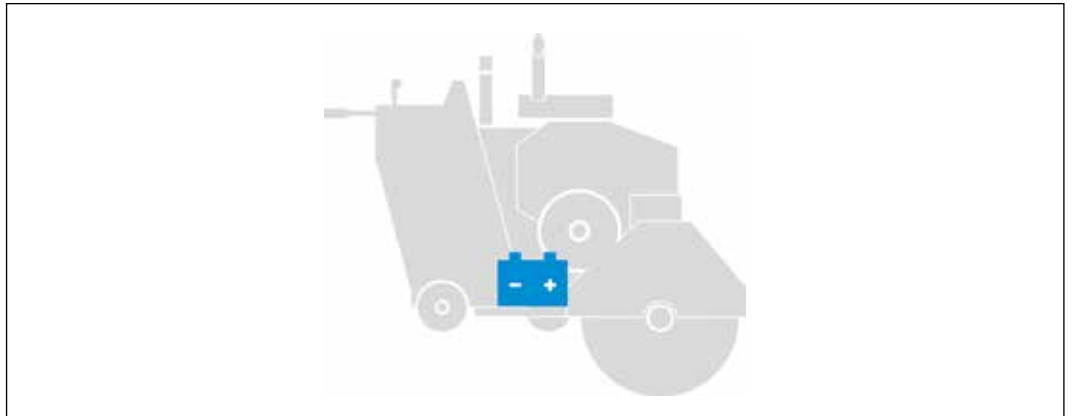

Battery (diagram)



#### **INFORMATION**

Use a suitable battery tester to check the battery strength.

Wear protective goggles or face protection and avoid contact with the skin when handling and servicing the battery.

The floor saw contains a charged battery with a positive cable (red) and a negative cable (black).

#### 3.3.1 Battery maintenance

Proceed as follows:

Detach the battery from the holder

- ▶ Disconnect the negative cable (black) from the negative terminal.



#### **INFORMATION**

Always disconnect the negative cable first.

- ▶ Disconnect the positive cable (red) from the positive terminal.
- ▶ Remove the battery.
- ▶ When cleaning the battery, inspect the terminals, clamps and cables for damage and corrosion. Clean the poles and terminals with a wire brush. Grease the battery terminals and poles with acid-free, acid-resistant grease.
- ▶ Carefully reinsert the battery in the battery box.
- ▶ Reconnect the positive cable.



#### **INFORMATION**

- ▶ Always reconnect the positive cable (red) first.
- ▶ Reconnect the negative cable (black).
- ▶ Place the battery compartment cover on the two screws of the pull rod and tighten with the two ratchet knobs.



### 3.4 Cut indicator

If necessary, use the cut indicator to follow the cutting line. Before cutting, always check that the cut indicators are correctly aligned with the saw blade.

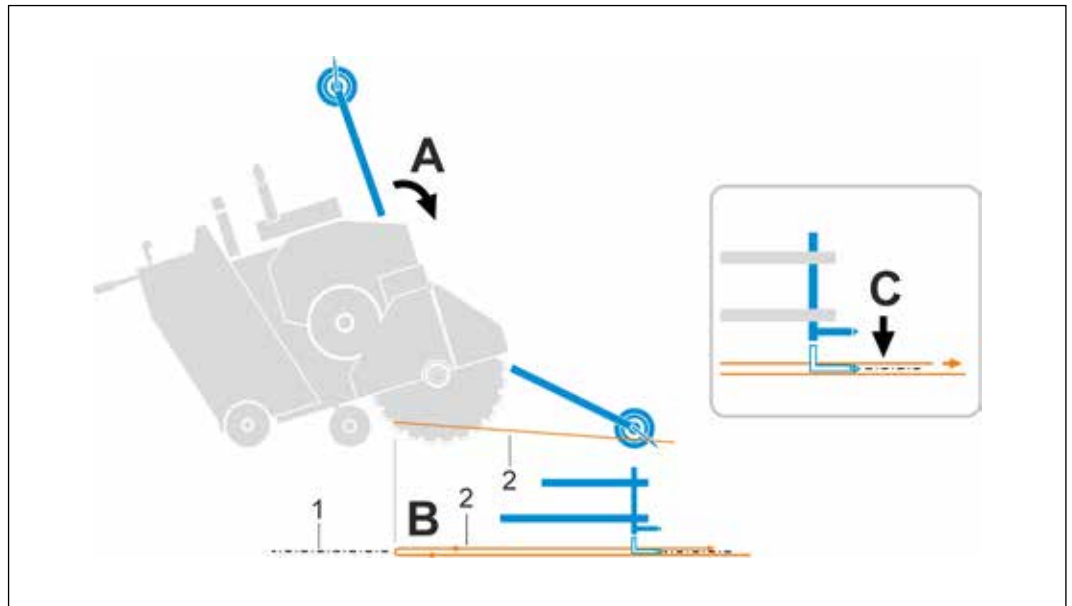

Cut indicator (diagram)

- 1 Cutting line
- 2 String

#### Adjusting the front indicator

- ▶ Lower the front indicator frame to the floor (A).
- ▶ Undo both screws in the front indicator frame.
- ▶ Divide an 8-10 m-long piece of string (B) into two halves.
- ▶ Extend the string from the saw blade to the cutting line of the indicator
- ▶ Adjust the indicator rod so that the tip is between the tensioned strings (C).
- ▶ Lock the cut indicator in place.

#### Adjusting the rear indicator(s)

- ▶ Undo the nut and bolt of the rear indicator on the back of the frame base.
- ▶ Align the rear cut indicator with the cutting line and tighten the nut and bolt once more.

### 3.5 Handle adjustment



#### INFORMATION

The length and height of the handles can be adjusted to an ergonomic position. The handlebars help you to guide and manoeuvre the floor saw. Move the handlebars to the desired position for better leverage when lifting and steering. To manoeuvre the floor saw forwards and backwards, turn on the freewheel switch and move the floor saw as desired.

The freewheel only works when the ignition key is turned to ON.

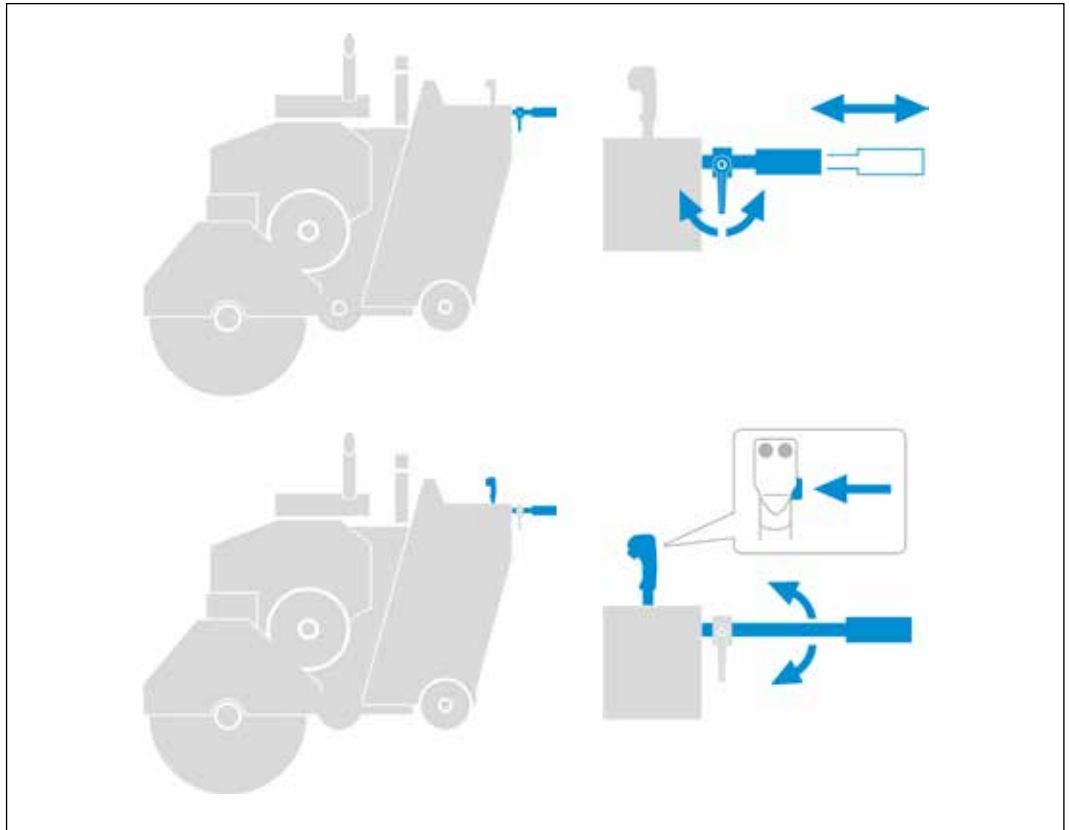

Handle adjustment (diagram)

#### Adjusting the handlebar

- ▶ Undo the handlebar adjustment lever.
- ▶ Move the handlebar forwards or backwards to adjust the length, then tighten the adjustment lever once more.
- ▶ Press the pushbutton on the side of the steering handle for inclining the guide bar, and move the guide bar up or down to adjust the angle.

## 3.6 Light



### INFORMATION

Adjust the light so that the work area is well lit.

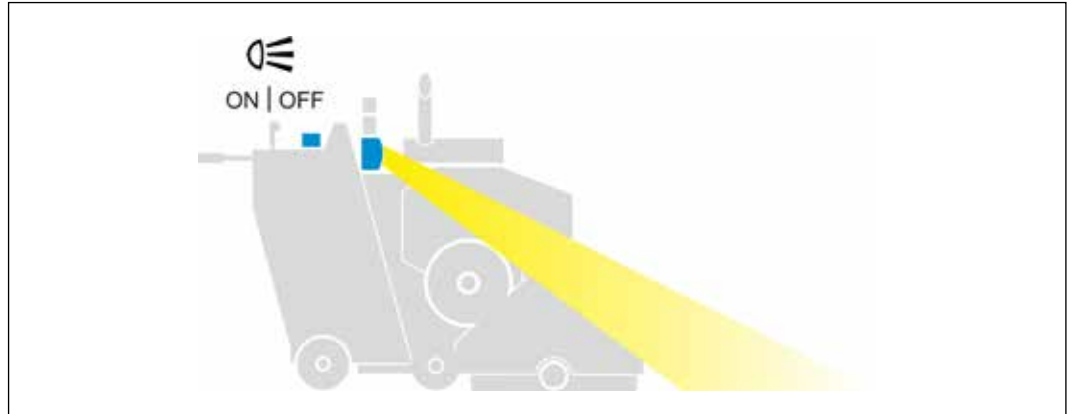

Light (diagram)

## 3.7 Fuel



### INFORMATION

Always be careful when refuelling.

- ▶ Do not operate the floor saw if fuel is leaking.
- ▶ Do not refuel the floor saw while the engine is running.
- ▶ Do not smoke or expose to naked flames.



### INFORMATION

Pay attention to the engine manufacturer's instructions.



Fuel

## 4 Operation

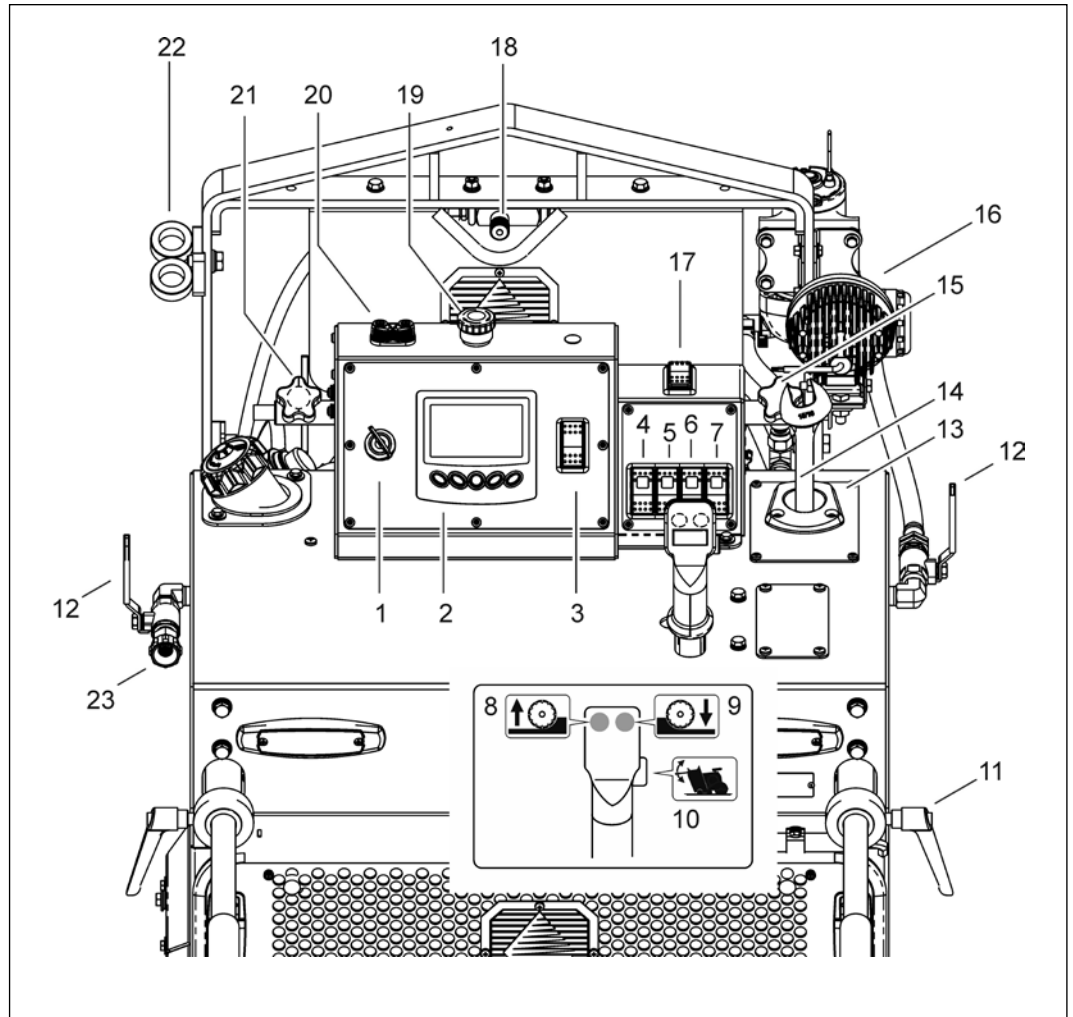

### 4.1 Overview of controls



#### Controls

- |    |                              |    |                               |
|----|------------------------------|----|-------------------------------|
| 1  | Ignition lock                | 13 | Tool holder                   |
| 2  | Control panel                | 14 | Combination wrench            |
| 3  | Engine speed toggle switch   | 15 | Light clamp handle            |
| 4  | Light toggle switch          | 16 | Light                         |
| 5  | Toggle switch (not assigned) | 17 | Freewheel toggle switch       |
| 6  | Toggle switch (not assigned) | 18 | Rotating valve lowering speed |
| 7  | Toggle switch (not assigned) | 19 | Emergency stop button         |
| 8  | Tool lifting pushbutton      | 20 | Indicator cord clamp          |
| 9  | Tool lowering pushbutton     | 21 | Light clamp handle            |
| 10 | Handle adjustment pushbutton | 22 | Handle holder                 |
| 11 | Clamp handle                 | 23 | Water connection              |
| 12 | Water metering control valve |    |                               |

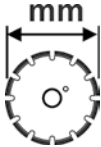
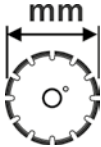
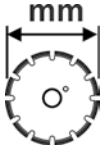
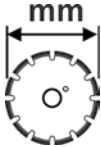
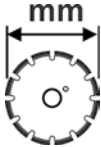
## 4.2 Cutting data table

FSD1274					
					
	mm	M L H	1/min.	mm	
 2600 rpm	700 (28")	H	1675	242	
	750 (30")	M	1225	267	
	800 (32")			292	
	900 (36")			342	
	1000 (~42")			392	
	1200 (48")	L	950	492	



**INFORMATION**

The belt pulley may only be changed by a Tyrolit Hydrostress engineer or a trained specialist.



**INFORMATION**

Only change the gear when the engine is at a standstill. Never handle the shift device when the engine is running.

### 4.3 Control panel



**INFORMATION**

This section describes functions and on-screen displays.

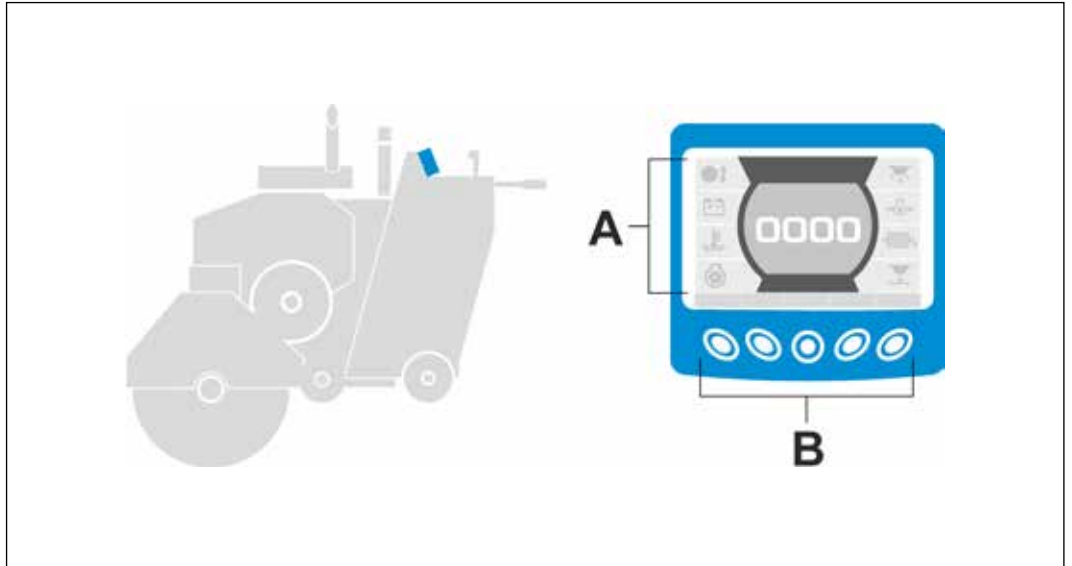

Control panel

- A Screen
- B Function keys

#### 4.3.1 Screen

The screen displays warnings, commands, error messages and menu options for setting up the floor saw.

**On-screen pictograms**

Left side of screen		Right side of screen	
	Saw blade diameter		Plunge depth
	Battery voltage		Engine oil pressure
	Engine coolant temperature		Soot content (%)
	Engine operating hours		Cutting depth stop



**INFORMATION**

The blade speed, engine speed and engine torque are displayed in the centre of the screen. You can switch between displays using the middle function key.



Blade speed (orange)



Engine speed (green)





Engine torque (blue)



**INFORMATION**

The area of the display for warnings is directly above the large central display. When certain conditions occur, the following symbols are displayed in this area.

	<p>Parking brake - The green symbol lights up when the hydraulic parking brake is engaged.</p>
	<p>Fuel level - The red symbol lights up when the fuel level is too low.</p>
	<p>Water in fuel - The red symbol lights up when water is detected in the fuel tank.</p>
	<p>Battery voltage - The red symbol lights up when the battery voltage is too low.</p>
	<p>Maintenance required - The yellow symbol lights up when a mandatory maintenance milestone is reached.</p>
	<p>Check engine:            The yellow symbol lights up when the control unit receives a DM1 message with a yellow lamp command.</p> <p>   The red symbol lights up when the control unit receives a DM1 message with a red lamp command.</p>
	<p>Oil pressure - The red symbol lights up when the oil pressure is too low.</p>
	<p>Coolant temperature - The red symbol lights up when the coolant temperature is high.</p>
	<p>Low coolant level - The red symbol lights up when the coolant level is low.</p>
	<p>High transmission temperature - The red symbol lights up when the transmission temperature reaches 121 °C (250 °F).</p>
	<p>Clutch engaged - The green symbol lights up when the optional blade clutch is engaged.</p>
	<p>Idling speed - The green symbol lights up when the transmission is idling.</p>

	High engine exhaust temperature lamp - The red symbol appears during active DPF regeneration if the DPF exhaust temperature is above 450 °C/842 °F and fuel injection is taking place downstream of the engine.
	Regeneration required - The yellow icon symbol is displayed continuously to request automatic regeneration when "Prevent" has been set for regeneration. The symbol turns red when regeneration is necessary.
	DPF regeneration set to Prevent - Yellow symbol appears when the machine or operator has prevented regeneration.



**INFORMATION**

There is a clock directly below the large central display. All active error states are also displayed in this area.

**4.3.2 Function keys**

When the function keys are pressed, they correspond to the function commands and permit corresponding selection. The choice of commands is displayed at the bottom of the screen.



















Function keys



### 4.3.3 Function commands

A command can be selected from the horizontal row of commands at the bottom of the screen by pressing the function key directly below it. The function options available for this floor saw are listed below:

	Description
	Saw blade diameter - Switches to the "Select saw blade diameter" screen.
	Shift key for: <ul style="list-style-type: none"> <li>- Blade speed display</li> <li>- Engine speed display</li> <li>- Engine torque display</li> </ul>
	Main menu - Switches to the three options: Engine diagnostics   User settings   Utilities
	Zero cut - Sets the reference point for adjusting the saw blade
	Depth setting (inactive) - Work without defined depth of cut.
	Depth setting (active) - Work with defined depth of cut
	Select - Enters the action highlighted on screen
	Left arrow - Moves the cursor to the left
	Right arrow - Moves the cursor to the right
	Up arrow - Moves the cursor up
	Down arrow - Moves the cursor down
	Plus - Increases a numeric marker
	Minus - Decreases a numeric marker
	Back - Returns to the previous screen
	Reset - Resets the service reminder hours for maintenance milestones when maintenance is complete.
	Error information - Provides additional information about active/saved errors.

### 4.3.4 Main menu



#### INFORMATION

Press the MENU key to view the list of the three available menu options:

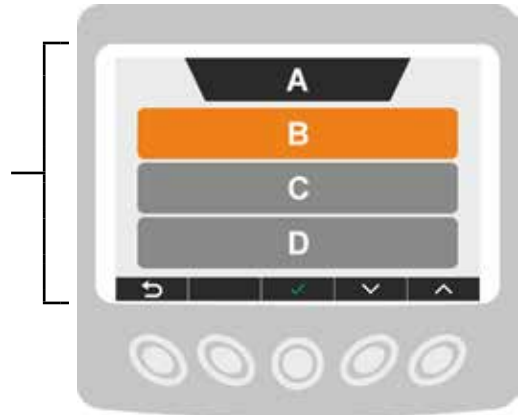
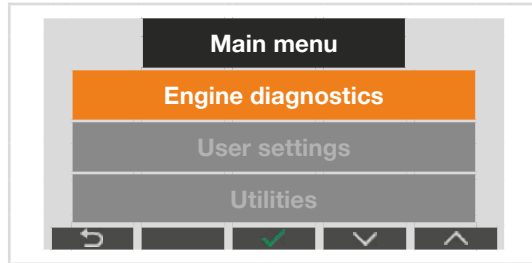

#### Main menu (A)

- Engine diagnostics (B)
- User settings (C)
- Utilities (D)

### 4.3.5 Engine diagnostics



#### INFORMATION

The screen displays the following items:

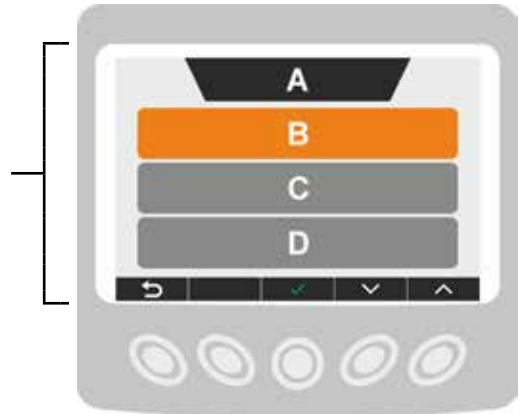
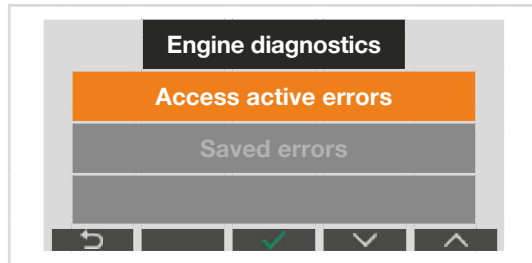

#### Engine diagnostics (A)

- Access active errors (B)
- Saved errors (C)

### Access active errors (B)



#### INFORMATION

This screen displays active errors or warnings from the electronic control unit (ECU). Each diagnosis is displayed with the corresponding Suspect Parameter Number (SPN), Failure Mode Indicator (FMI), text description (if available), and the source of the device that sent the diagnostic message.

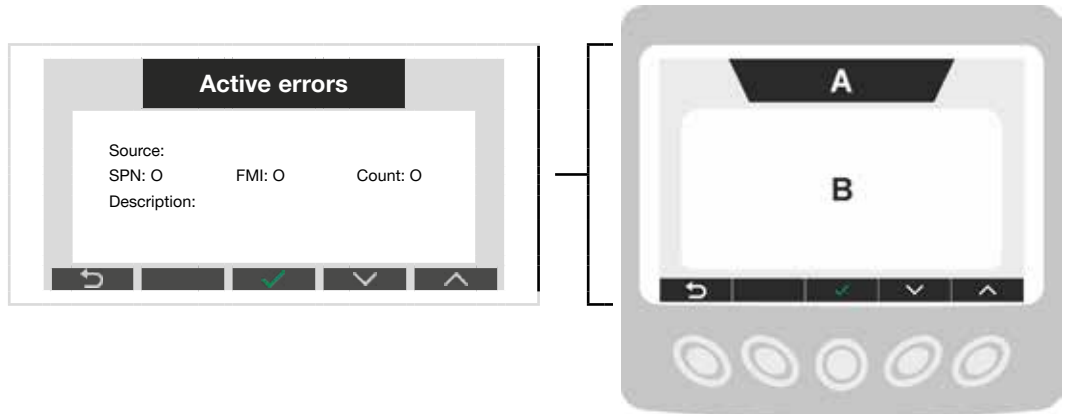

#### Active errors (A)

- Source/Description (B)

### Access stored errors (C)



#### INFORMATION

This screen displays the non-active errors or warnings from the control unit. Each diagnosis is displayed with the corresponding Suspect Parameter Number (SPN), Failure Mode Indicator (FMI), text description (if available), and the source of the device that sent the diagnostic message.

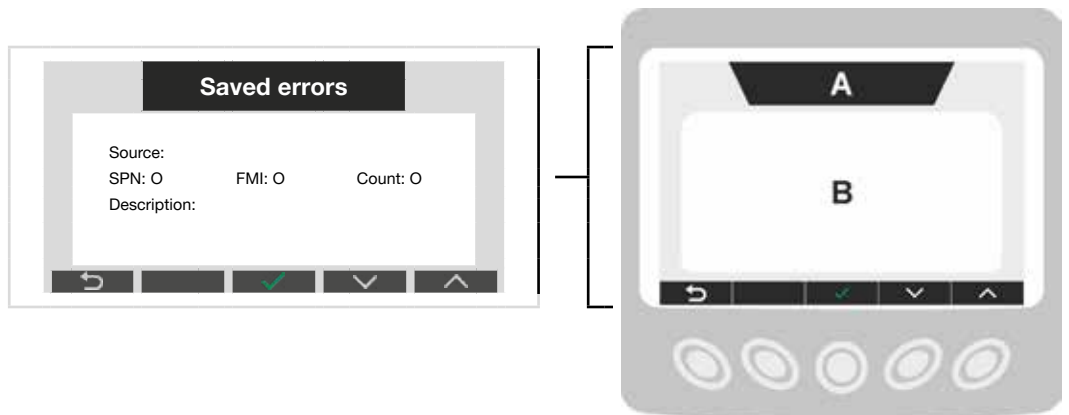

#### Saved errors (A)

- Source/Description (B)

### 4.3.6 User settings



#### INFORMATION

The user settings consist of a row of setting options (B to E), which can be accessed in two consecutive screens.

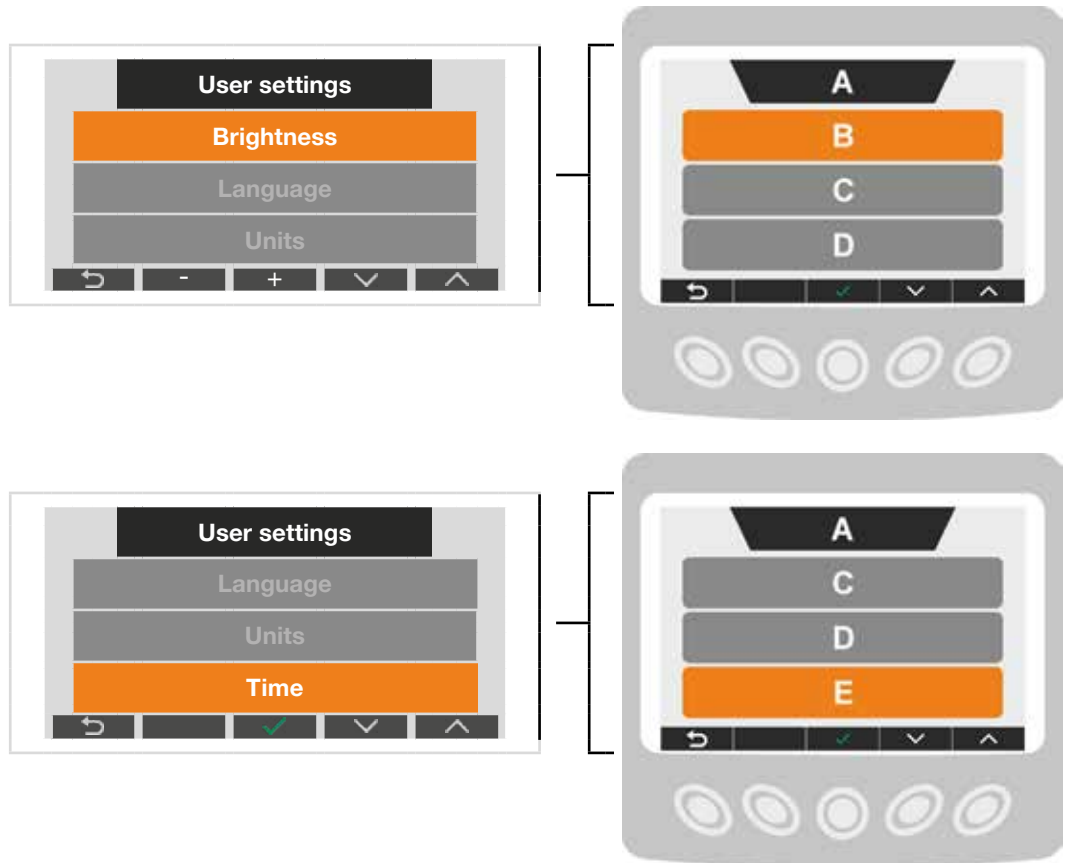

#### User settings (A)

- Brightness (B)
- Language (C)
- Units (D)
- Time (E)

#### Brightness (B):

This option allows the operator to increase or reduce the intensity of the backlight as needed in order to see the screen clearly.

#### Language (C):

There are five languages to choose from:  
DE / EN / ES / FR / IT

#### Unit (D):

This option allows the operator to choose between metric and standard (US) units.

#### Set the time (E):

This option allows the operator to set and update the time on the clock display (save settings). The clock remains in operation when the device is switched off. The clock only needs to be reset and updated if the battery voltage has been interrupted.

### 4.3.7 Utility



#### INFORMATION

The Utilities screen displays the following items:

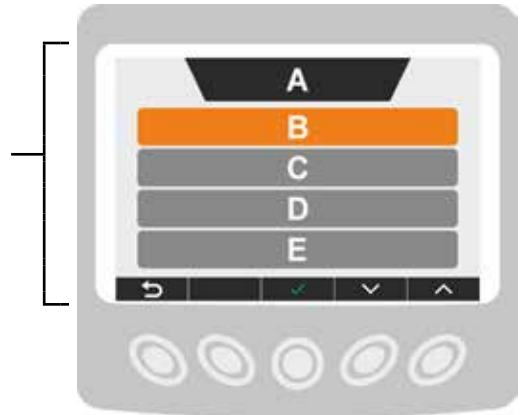
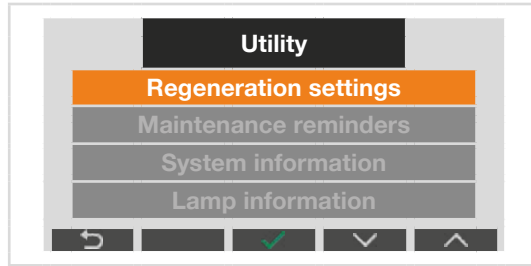

#### Utility (A)

- Regeneration settings (B)
- Maintenance reminders (C)
- System information (D)
- Lamp information (E)

#### Regeneration settings (B)



#### INFORMATION

This menu displays a screen showing the available regeneration options for the diesel particulate filter (DPF) and the time since the last regeneration was completed. The machine is factory-set to allow active DPF regeneration. By selecting the appropriate option, the regeneration process can be suppressed. It is also possible to request regeneration via this menu.

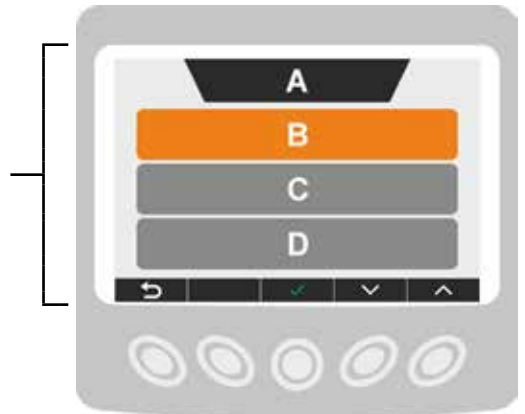
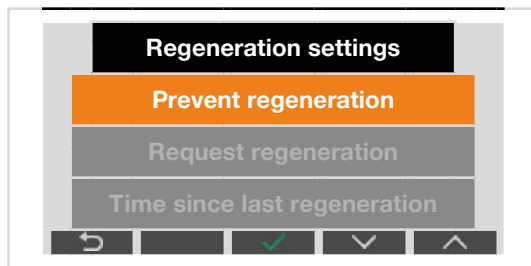

#### Regeneration settings (A)

- Prevent regeneration (B)
- Request regeneration (C)
- Time since last regeneration (D)

### Maintenance reminders (C)



#### INFORMATION

This option consists of two screens that display the five critical maintenance reminders with the time in hours at which the next maintenance must be performed. When a maintenance item has been completed, the time for the next maintenance schedule can be reset. For more information on maintenance schedules, see the "Maintenance" section in this manual.

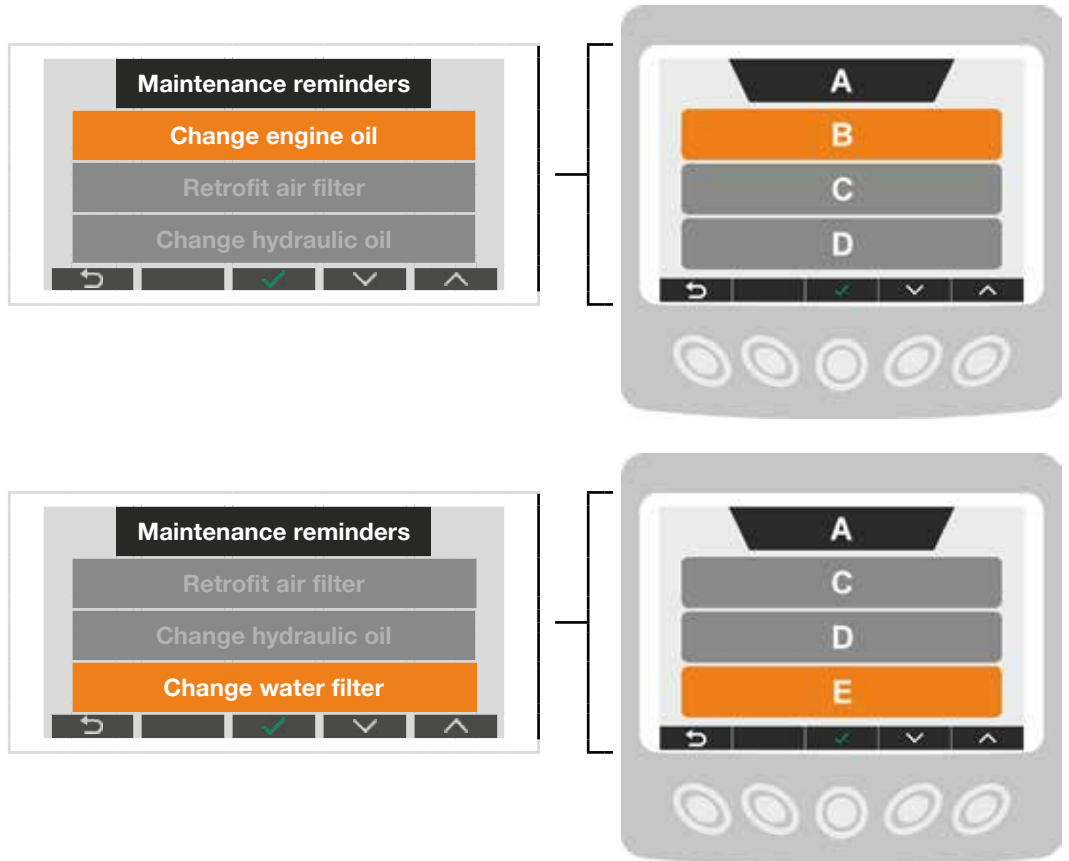

#### User settings (A)

- Change engine oil (B)
- Retrofit air filter (C)
- Change hydraulic oil (D)
- Change water filter (E)

### System information (D)



#### INFORMATION

The screen displays the following system information:

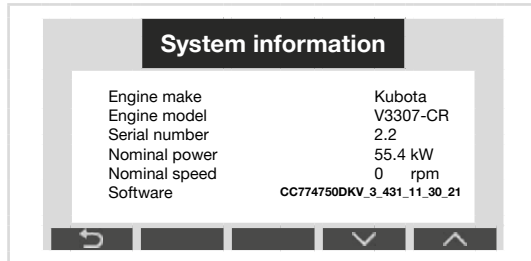

#### System information (A)

- System information (B)
- Engine make
- Engine model
- Serial number
- Nominal power
- Nominal speed
- Software

### Lamp information (E)



#### INFORMATION

The lamp information screen is for information only. It is possible to toggle between four screens, which describe the following four DPF regeneration conditions:

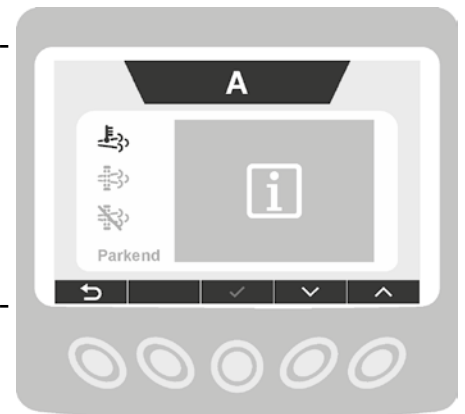
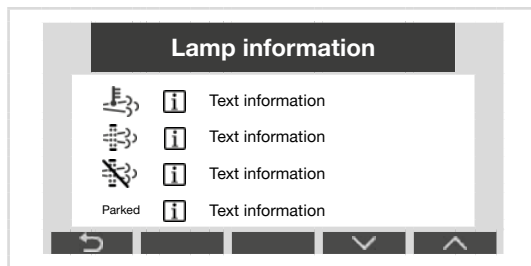

#### Exhaust lamp information (A)

- Active exhaust gas regeneration
- Exhaust gas regeneration requested
- Prevent exhaust gas regeneration
- Parked** Exhaust gas regeneration Parked

### 4.3.8 Selecting the saw blade diameter



#### INFORMATION

When the ignition switch is turned to ON, the display starts up. The first screen that appears is the "Select saw blade diameter" screen. It is extremely important to select the correct saw blade diameter for the saw blade that is mounted on the machine. If you have not selected the correct diameter, this will result in reduced cutting performance and/or serious injury! See the conversion tables in this section for speed and saw blade sizes.

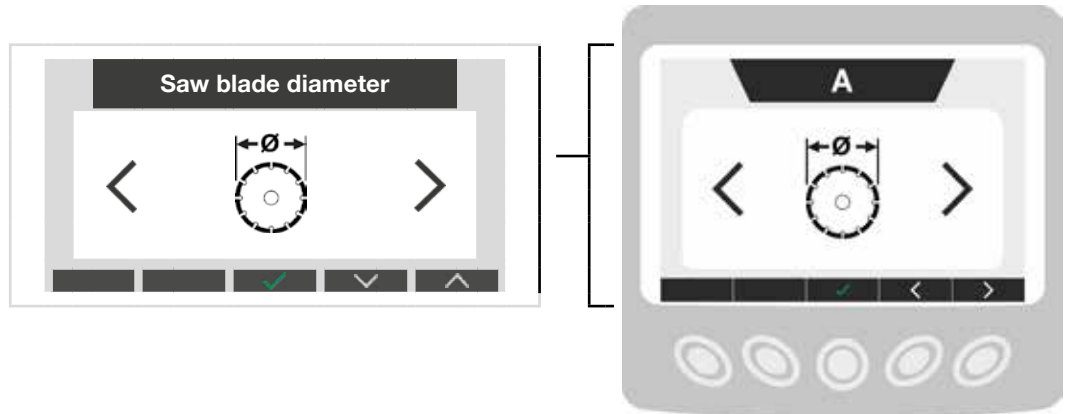

#### INFORMATION

To select the correct saw blade diameter:

1. Scroll through the available saw blade sizes using the function keys linked to the commands of the right and left arrow keys at the bottom right of the display panel.
2. When the correct size is displayed on the screen, press the "Select" function key (middle key) to apply that saw blade diameter. The "Home" screen is then displayed.

The saw blade size can also be selected in the "Home" screen by pressing the left function key linked to the "Saw blade size" softkey command. When this button is pressed, the "Select saw blade size" screen opens.



### 4.3.9 Zeroing the cutting depth setting

- ✓ Make sure the saw is in operation and all safety precautions are followed.
  1. Lower the saw blade to just above the cutting area.
  2. Press the second function key on the right twice until the upper right-hand display shows 0.00 millimetres or inches.

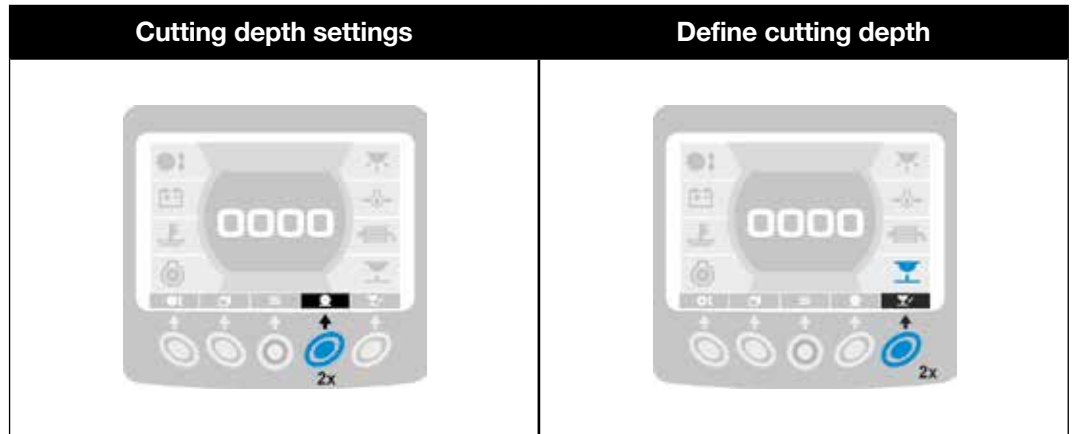

The saw blade is now set to zero. When the saw blade is lowered into the cut, the display increments in the selected units (millimetres or inches) to indicate the depth of the cut.

#### Define cutting depth

Proceed as follows:

- ▶ Zeroing the cutting depth setting
- ▶ Lower the saw blade into the cut to the desired depth.
- ▶ Press the rightmost function key on the display panel twice until "Depth stop active" appears at the bottom right of the display panel.

#### Deactivating cutting depth settings

Proceed as follows:

- ▶ Press the rightmost function key twice until the bottom right-hand display shows 0.00.

## 4.4 Starting the floor saw

Proceed as follows:

- ✓ The danger zone is secured
- ✓ The work area is well ventilated
- ✓ The water supply is secured
- ✓ EMERGENCY STOP is deactivated
- ✓ All controls and switches are switched off or set to 0
- ✓ All flaps and covers are closed
- ✓ The blade guard is mounted and secured



### INFORMATION



Pay attention to the engine manufacturer's instructions.

- ▶ Check the air filter

The meaning of the display in the viewing window is as follows.

Colour of display	Meaning
Yellow	Air filter OK
Red	Air filter clogged

- ▶ If the air filter is clogged, change the air filter.
- ▶ Check the fuel level and top up diesel if necessary.
- ▶ Check the oil and coolant levels.
- ▶ Position the floor saw.
  - Push the floor saw into working position.
  - Align the floor saw with the cut indicators.
- ▶ Establish the water supply to the floor saw.
- ▶ Switch on the engine.
  - Insert the key into the ignition lock, turn the key to ON and wait until the display lights up.



### INFORMATION

While the display is starting up, the glow plug is preheated. If the glow plug needs more time to preheat, the following pop-up message appears: "Waiting for start, preheating".

- Once the screen is active and no more pop-up messages appear, turn the key to START and release it when the engine starts.





### INFORMATION

If the engine does not start within 10 seconds, turn off the ignition key and try again about 30 seconds later. For information on troubleshooting, see the engine manual.

- Allow the engine to warm up. Check all warning lights and switch off the engine immediately if problems occur.
- Increase/decrease the engine/blade speed by pushing the throttle control switch up or down as required.

### 4.5 Controlling the travel motion

Use the speed control lever to move the floor saw forwards and backwards.

Symbol	Meaning
	Feed regulator direction of travel forwards
	Feed regulator direction of travel backwards



#### INFORMATION

The engine must be running at least at half throttle to move the floor saw with the speed control lever.

#### Travel motion

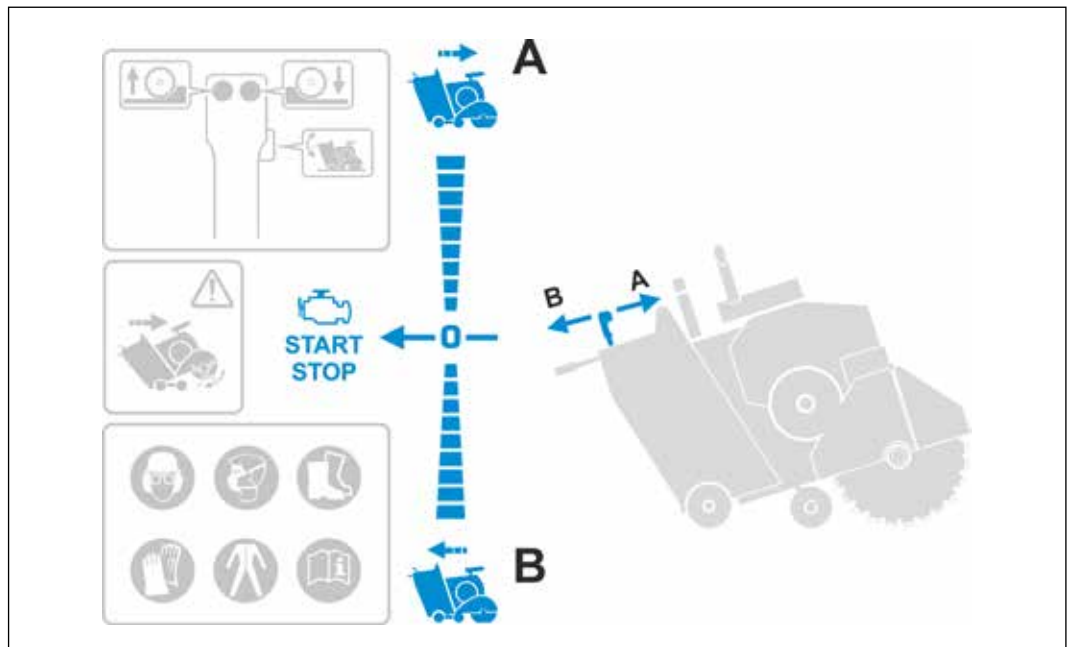

Travel motion (diagram)

- A Move forwards
- B Move backwards

- ▶ To move the floor saw forwards, slowly push the lever forwards and release when you have reached the desired speed.
- ▶ To move the floor saw backwards, slowly pull the lever back and release when you have reached the desired speed.
- ▶ To bring the floor saw to idling speed, move the lever to Stop.



#### INFORMATION

The Stop position does not have a braking function



### 4.6 Lifting and lowering the blade

To lift the saw and saw blade, press the Lift (left) pushbutton, and release it to stop.



Lifting and lowering the blade



#### INFORMATION

Note: Always lift the saw blade when manoeuvring the saw to ensure adequate clearance between the blade and the floor.

- ▶ To lower the saw and blade, press the Lower (right) pushbutton, and release it to maintain the cutting depth.

#### 4.6.1 Blade lowering speed

Turn the valve anti-clockwise to increase the lowering speed of the saw blade, and clockwise to decrease the lowering speed of the saw blade.



Blade lowering speed (diagram)

### 4.7 Correcting tracking



#### INFORMATION

When cutting is in progress, you can correct the tracking using the adjusting screw on the rear wheel axle.



Correcting the tracking (diagram)

### 4.8 Shifting gears with the 3-speed transmission



**DANGER**

Death or serious injury can result if gears are shifted while the engine is running. Do not attempt to shift gear while the engine is running.



Shifting gears with the 3-speed transmission (diagram)

Proceed as follows:

- ▶ Switch off the engine.
- ▶ Allow the engine to cool.
- ▶ Unlock and lift the hood of the engine.
- ▶ Lift the gear lever and hold it while turning the saw blade flange back and forth with the tool wrench.
- ▶ Slide the gear lever over the desired slot in the shift gate (from left to right, Medium, Low, Neutral, and High, marked M, L, N and H, respectively).

Gear position (designations)	Meaning
M = Medium	Medium speed
L = Low	Low speed
N = Neutral	No gear engaged
H = High	High speed



**INFORMATION**

To perform this movement, you must manually rotate the output shaft.

- ▶ Allow the gear lever to drop into the desired slot in the shift gate.

## 4.9 Switching off the floor saw (engine)



### **DANGER**

Death or serious injury can result if the floor saw continues running. Do not leave the floor saw unattended until the engine has stopped and the saw blade has stopped rotating.

Proceed as follows:

- ▶ Set the speed control lever to Stop and swing the saw blade out of the cut.
- ▶ Switch off all controls, switches and the water supply.
- ▶ Reduce the engine speed to idling for five minutes to cool down the engine after full load operation.
- ▶ If necessary, switch the "Freewheel" toggle switch to Brake.
- ▶ Turn the ignition key to Stop and remove the key.

## 4.10 After work

Proceed as follows:

- ▶ Blow water out of all pipes.
- ▶ Clean the floor saw, control panel and cables with a damp cloth.

## 5 Servicing and maintenance



### INFORMATION

The maintenance work described below must be carried out in the maintenance cycles described here. Wear parts that are not subject to specific maintenance intervals must also be checked regularly for wear and adjusted or replaced if necessary. In the case of combustion engines, maintenance work must be performed in line with the separate maintenance instructions from the engine manufacturer.

Servicing and maintenance table					
	Daily	After 50 working hours	After 100 working hours	After 250 working hours	After 500 working hours
Visually inspect the floor saw for damage and repair if necessary.	X				
Wipe down all components and clean away dust, dirt and mud.	X				
Check that all protection devices are in place and in good condition.	X				
Check for loose or frayed cables. Repair or replace as necessary.	X				
Check for loose bolts and nuts and retighten if necessary.	X				
Check all hoses for damage, leaks, or looseness and blow out or replace as needed.	X				
Check all belts for tension and wear, retighten as needed.	X				
Check engine oil level.	X				
Check fuel level.	X				
Check hydraulic fluid.	X				
Check coolant level in radiator.	X				
Check and clean water spray pipes.	X				
Check air filter limit indicator.	X				
Blow out water supply system with air (only in cold weather).	X				

**Servicing and maintenance table**

	Daily	After 50 working hours	After 100 working hours	After 250 working hours	After 500 working hours
Drain water from fuel/water separator filter	X <sup>1</sup>				
Lubricate hydraulic cylinder pivots	X				
Lubricate front axle bearings	X				
Lubricate bogie	X				
Change upper transmission oil		X <sup>2</sup>			
Change lower transmission oil			X <sup>2</sup>		
Clean oil intake filter			X		
Check and clean the intake strainer(s) of the water system				X <sup>1</sup>	
Clean air filter element				X <sup>3</sup>	
Change engine oil and replace filter		(X) <sup>4</sup>		X	
Replace hydraulic oil filter element		(X) <sup>4</sup>			X
Replace water separator filter					X <sup>5</sup>
Replace fuel filter					X
Replace main and safety air filters					X <sup>2</sup>
Change radiator coolant					X <sup>6</sup>
Lubricate seals of saw blade spindle					X <sup>6</sup>

X<sup>1</sup> Service as needed

X<sup>2</sup> Initial change after 20 operating hours

X<sup>3</sup> Clean more frequently when operating in dusty environments

X<sup>4</sup> First change at 50 operating hours

X<sup>5</sup> ... or 1 year, whichever comes first

X<sup>6</sup> ... or 2 years, whichever comes first



## 5.1 Tools for maintenance



### INFORMATION

Tools that are important for machine maintenance are included in the scope of delivery of the machine.

Tool table	
	
15"/16" Combination wrench	<ul style="list-style-type: none"> <li>• Installation and removal of saw blades</li> </ul>
1 1/16" / 1 1/8" Combination wrench	<ul style="list-style-type: none"> <li>• Adjusting belt tension of blade drive</li> </ul>
3/8" Allen key	<ul style="list-style-type: none"> <li>• Adjusting speed lever tension</li> </ul>

## 5.2 Preparations for maintenance



### INFORMATION

- Make sure the floor saw is in a safe area before performing maintenance.
- Make sure that the floor saw has cooled down sufficiently before performing maintenance.
- Remove the saw blade before starting maintenance.
- Place the saw on a level surface, switch off the engine and activate the emergency stop switch.
- Secure the floor saw so it cannot roll away.
- Make sure that all equipment and tools required for maintenance work are to hand and can be used.
- Familiarise yourself with the location of all safety devices such as fire extinguishers, first aid kits, etc. before performing maintenance.

## 5.3 Cleaning



### INFORMATION

The floor saw must be cleaned before any maintenance work is performed. Make sure that the floor saw has cooled down before cleaning. Make sure that affected electrical equipment is properly covered or de-energized before cleaning with water or air.

### 5.3.1 Cleaning methods

Various cleaning methods can be used, depending on the type of cleaning required. A pressure washer and mild detergent are the most suitable. Compressed air and low-pressure water can also be used if necessary.

Caution is advised when using high-pressure water and compressed air to perform maintenance or cleaning. High-pressure water and compressed air can injure persons or damage equipment if used incorrectly.

### 5.3.2 Radiator

Make sure that the radiator has cooled down before cleaning. Clean the radiator fins with compressed air, taking care not to damage the fins. A mild detergent with low-pressure water can also be used to degrease the radiator.



#### INFORMATION

Damaged radiator fins can and will reduce the radiator's cooling capacity.

### 5.3.3 Control panel

#### INFORMATION

Do not spray water onto the control panel to clean it. Use a damp cloth or compressed air to clean electrical components. Dry the control panel after cleaning.

### 5.3.4 Screen



#### INFORMATION

Do not spray water onto the screen to clean it. Wipe it with a damp cloth and dry with a lint-free cloth.

### 5.3.5 Engine

To clean the engine, use a mild detergent and water. Do not forcefully spray water onto the engine to avoid damage to components.



#### INFORMATION

Do not spray water into the exhaust pipe or air filter.

### 5.3.6 After cleaning

- ▶ Dry the machine as required.
- ▶ Dry all electrical components with compressed air.
- ▶ Do not operate the machine until it is completely dry.

## 5.4 Lubrication



#### DANGER

Death or serious injury can result if lubrication is performed with the engine running. Do not lubricate parts while the engine is running.

Lubricate all necessary parts to ensure maximum efficiency of the saw. Lubricate controls, cables, hinges, locks and linkages occasionally with a spray lubricant when movement becomes slow and/or sluggish. Use one to two full pump strokes of high-quality NLGI lithium-based No. 2 grease to lubricate all grease nipples.

### 5.4.1 Lubrication points with grease nipples

- Hydraulic cylinder
- Saw blade shaft bearings
- Lifting axle bearings

## 5.5 Hydraulic system



### DANGER

#### Injuries due to escaping hydraulic oil.

- ▶ Check all hydraulic hoses and connections daily for leaks. Remember to use cardboard or a piece of paper when checking for leaks and replace damaged components immediately
- ▶ Keep all body parts away from leaks and/or areas where hydraulic fluid may escape. Pressurized hydraulic fluid can penetrate the skin and cause serious injury.
- ▶ Always make sure that the hydraulic components to be serviced do not bear the weight of other floor saw components. When a particular component is under pressure, oil can spurt out violently when connections are detached.

### 5.5.1 Filling levels

Check the following levels before starting up.

- Hydraulic pump reservoir
- Lifting pump



### INFORMATION

Check the fluid daily and add fluid to the pump and pump reservoir when necessary.

### 5.5.2 Replacing the hydraulic oil filter

Replace the hydraulic oil filter after the first 50 hours of operation and then every 500 hours.

Proceed as follows:

- ▶ Place a drip pan under the filter.
- ▶ Remove the filter with a suitable tool.
- ▶ Dispose of the used oil and filter according to regulations.
- ▶ Wipe the sealing surface with a clean cloth and use clean oil to lightly lubricate the filter seal.
- ▶ Fit the new filter.

## 5.6 Belts



### INFORMATION

Be extremely careful when working with belts and rotating machine parts to avoid getting caught or pinched.

- ▶ Stop the engine and allow the belts to cool before servicing them.
- ▶ Check the belts regularly for fraying, stress cracks and breaks and replace them immediately if damaged.
- ▶ Always check the alignment of the belts before operating the equipment.



### INFORMATION

Overtensioning the belts can shorten the life of the transmission bearings. Undertensioned belts can cause slippage, a shorter belt life and/or poor equipment performance.

## 5.7 Blowing out water

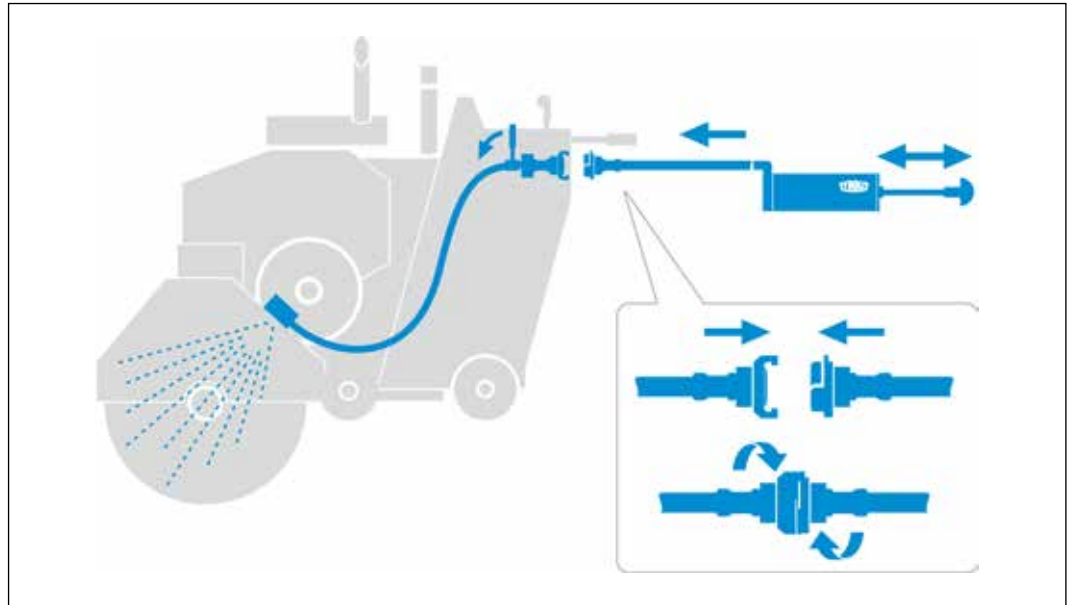

Blowing out water (diagram)

Proceed as follows:

- ✓ Ignition switch turned to **STOP**
- ▶ Detach all water lines.
- ▶ Connect the purge pump to the water connection.
- ▶ Blow out water until all water has been removed.
- ▶ Remove the pump.

## 5.8 Recycling waste materials

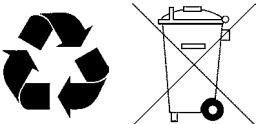

Tyrolit Hydrostress machines are manufactured using a large proportion of recyclable materials. A prerequisite for recycling is proper material separation. In many countries, Tyrolit has already set up arrangements for returning your old equipment for recycling. Ask Tyrolit Customer Service or your sales advisor.

## 6 Troubleshooting



### INFORMATION

You can find information on system malfunctions and errors shown on the control panel display in the description of the control panel.

### 6.1 Troubleshooting table

Troubleshooting		
Engine does not start	No more fuel	Fill the fuel tank.
	Fuel lines clogged	Flush or replace fuel lines.
	Air in fuel lines	Bleed fuel lines.
	Is the battery empty?	Charge or replace the battery
	Faulty battery connection	Check, clean and tighten battery cables.
	Engine malfunction	See engine manual.
	Faulty fuse	Check and replace faulty fuses.
The engine does not start because a shutdown condition is indicated on the display panel.  NOTE: All problems must be corrected before the floor saw will restart.	EMERGENCY STOP is active	Deactivate EMERGENCY STOP.
	Rear door panel is open	Close and lock the doors.
		Check that the door lock switch is working properly.
Low engine coolant level warning is shown on the display panel.  NOTE: The floor saw continues to run at reduced power until the engine is switched off. If the problem is not corrected, a shutdown warning will be displayed the next time the key is turned to "ON".	The coolant level is extremely low	Fill the cooling system as described in the "Maintenance" section.
Saw cannot be lifted	Faulty solenoid switch	Replace the solenoid valve on the hydraulic unit
	Battery voltage too low	Charge or replace the battery.

Troubleshooting		
Saw cannot be lifted	Faulty lifting button	Replace the lifting button.
	Not enough hydraulic oil	Check the hydraulic fluid level and top up if necessary.
Saw cannot be lowered	Deposits in the lowering valve stem	Check and clean the valve stem.
	Battery voltage too low	Charge or replace the battery.
	Faulty valve coil	Check that the valve stem is magnetic when actuated.
	Faulty lowering button	Replace the lowering button
The saw does not lower completely	Depth stop is set	Cancel the depth stop.
	Skid plates in the wrong holes.	Move the skid plates to the correct set of mounting holes.
	Maximum cutting depth incorrectly set	Adjust the screw for the maximum cutting depth.
The saw lowers too slowly or too quickly	Lowering speed is incorrectly set	Adjust the valve for the blade lowering speed.
Cutting is not straight	Wheel alignment switched off	Set the rear axle adjusting screw.
	Excessive force during sawing	Reduce the forwards speed. Do NOT turn the blade from one side to the other.
	Wrong blade	Contact the dealer/ manufacturer.
Short belt life	Loose belts cause slippage	Check and adjust the belt tension.
	Belt pulleys misaligned	Use a straight edge to check the alignment of the belt pulleys.
	Worn pulley grooves	Check whether pulley grooves are worn and replace if necessary.
	Wrong belts	Replace with a suitable set of belts. Do NOT use old and new belts together.

**INFORMATION**

If you were unable to remedy the fault, call our Service Centre (see manufacturer's address on the back of the cover page).

To ensure quick and professional troubleshooting, please prepare as follows before calling:

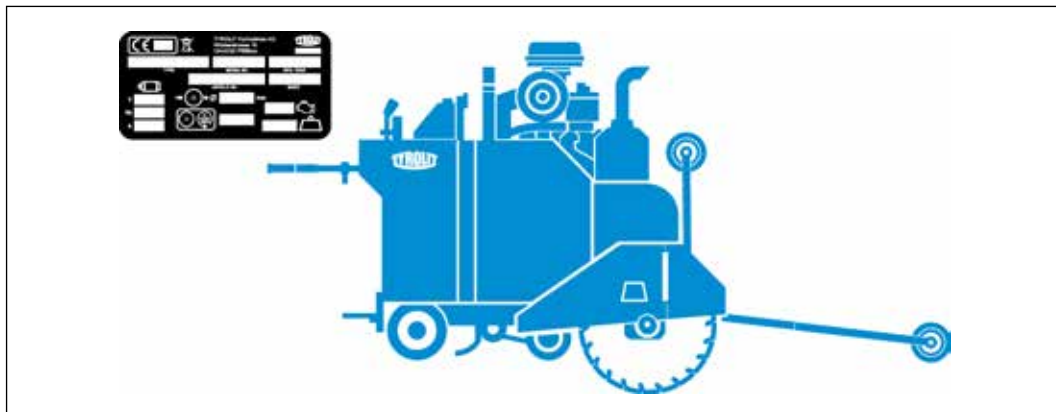

Type plate

**Proceed as follows:**

- ▶ Try to describe the fault as precisely as possible.
- ▶ Make a note of the type and index designation of your equipment (type plate).
- ▶ Have the operating instructions to hand.

## 7 Transport/Storage

### 7.1 Transport



#### DANGER

Improper transport can result in death or serious injury!

- ▶ Only transport the floor saw with the main engine switched off.
- ▶ Remove the saw blade before transport.
- ▶ Only use transport vehicles, lifting gear and load suspension devices with sufficient load-bearing capacity.
- ▶ Before lifting the saw, attach the appropriate lifting cables, straps and/or chains.
- ▶ Only lift the floor saw at the suspension point intended for this purpose.
- ▶ Designate a competent banksperson.
- ▶ Do not stand under suspended loads when transporting by crane.
- ▶ Always keep an eye on the floor saw during transport
- ▶ Never move the floor saw with the saw blade rotating.

#### 7.1.1 Suspension point

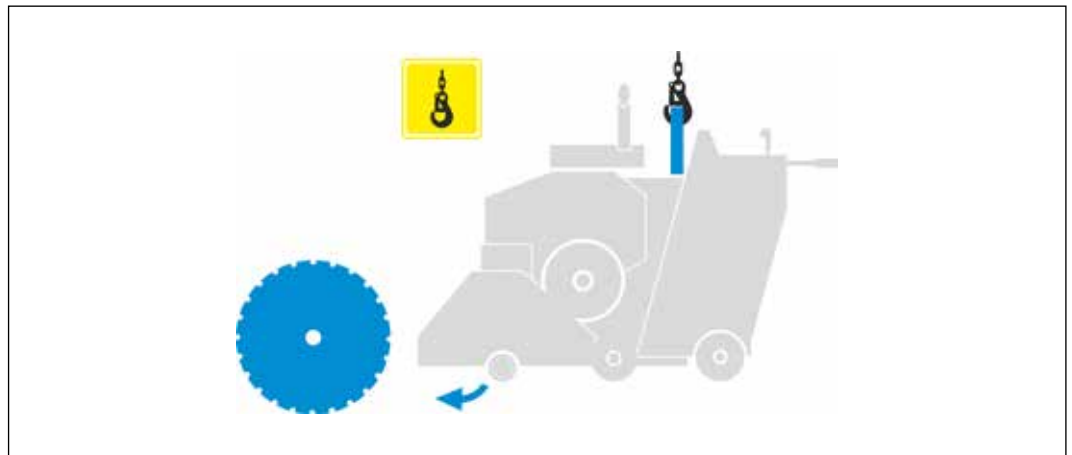

Suspension point (diagram)

### 7.2 Storage



#### INFORMATION

Perform the work described below before placing the floor saw in storage for an extended period of time:

- Drain the water lines/hoses.
- Switch off all switches and controls.
- Lower the floor saw to relieve the strain on the lifting mechanism.
- Clean the floor saw. Remove dust, debris and mud from components (especially fans).
- Take out the battery and store it in a suitable place.
- Follow all engine and fuel recommendations in the engine manual prior to storage.
- Store the floor saw in a dry place protected from the weather and out of the reach of children.



## 8 Technical data

### 8.1 Dimensions

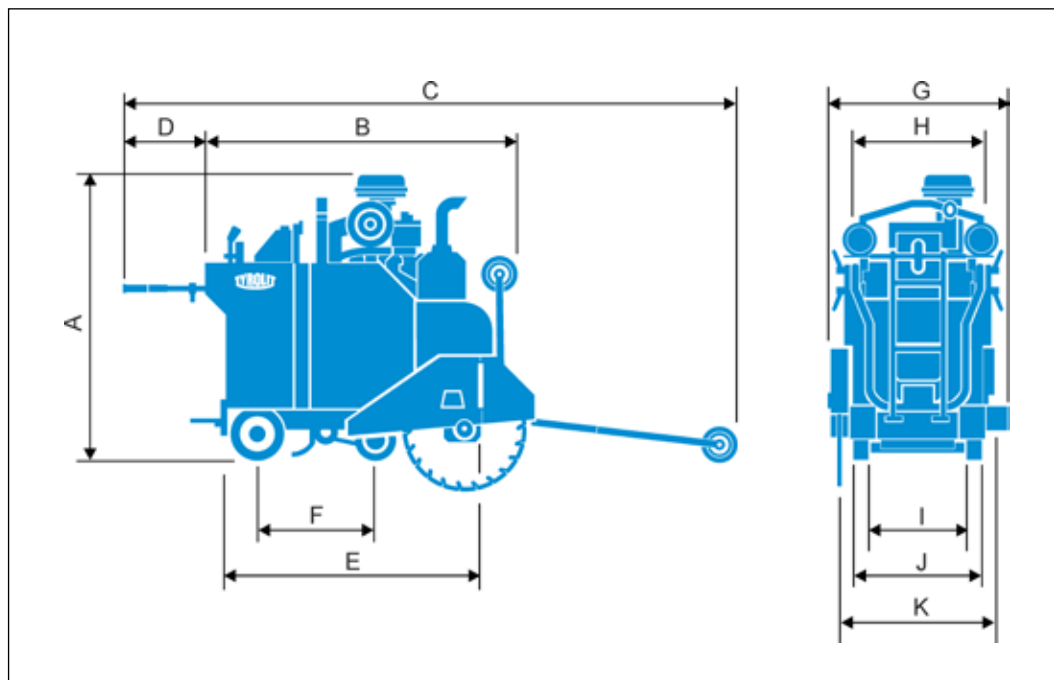

Dimensions in mm

Dimensions		
<b>A</b>	Height	1486 mm
<b>B</b>	Minimum length	1651 mm
<b>C</b>	Maximum length	3632 mm
<b>D</b>	Maximum handle extension	711 mm
<b>E</b>	Frame length	1365 mm
<b>F</b>	Wheelbase length	616 mm
<b>G</b>	Width	927 mm
<b>H</b>	Frame width	737 mm
<b>I</b>	Internal width of front wheels	520 mm
<b>J</b>	External width of rear wheels	692 mm
<b>K</b>	Width from inner flange to inner flange	806 mm
	Maximum saw blade height when raised	660 mm

## 8.2 Dimensions and weights

Dimensions	
Parameter	Value
Operating weight*	1056 kg
Transport weight incl. box	1102 kg
Dimensions of transported goods (with folded-up blade guard)	L: 1660 mm W: 930 mm H: 1490 mm

\* With blade guard and full fuel tank - without saw blade

## 8.3 Engine

Engine	
Parameter	Value
Model	KUBOTA V3307-CR-T-E5, 3.33 litres, 4-cylinder
Power	55.4 kW
Max. torque	265 Nm
Nominal speed	2600 rpm
Oil capacity	As per engine manufacturer's operating instructions
Tank capacity	32 litres (with fuel indicator)
Fuel	Ultra-low sulphur diesel (cetane rating 51 min)
Cooling	Water cooling/air cooling
Starter/alternator	Electric 3kW (4hp)/90 A
Engine air filtration	Dry double element with spinning pre-cleaner and restriction indicator
Belt drive	20 V-belt (3VX)

## 8.4 Recommended ambient temperature

Ambient temperature	
Parameter	Value
Storage	-20 °C to +50 °C
Operation	-10 °C to +45 °C

## 8.5 Lifting drive

Lifting drive	
Parameter	Value
Type of drive	Electro-hydraulic

## 8.6 Drive

Drive	
Parameter	Value
Type of drive	Hydraulic
Cooling	Air cooling
Speeds	Forwards: 0-67 m/min   backwards 0-25 m/min
Parking brake	Automatic hydraulic lock in Stop position

## 8.7 Sound level and vibrations

Sound level and vibrations	
Parameter	Value
Sound pressure level (L <sub>pA</sub> )	97.0 dB(A)*
Peak sound pressure level (L <sub>pCpeak</sub> )	120 dB
Sound power level (L <sub>wA</sub> )	117 dB(A)*
Vibrations DIN EN ISO 5349-2	< 2.5 m/s <sup>2</sup>

\* Value applies with the following condition: Drive is switched off and the saw blade is not engaged. The measurement was made at standstill, with engine under full load and saw blade Ø 1200 mm. Higher noise levels may occur during cutting operations.

## 8.8 Battery

Battery	
Parameter	Value
Voltage	12 V
Capacity	95 Ah
Version	Positive pole on left (circuit 1)
Dimensions	L x W x H = 330 x 173 x 240 mm (group31)
	L x W x H = 336 x 173 x 225 mm (DIN/ISO D31)

## 8.9 Saw blade and blade guard

Saw blade and blade guard	
Parameter	Value
Saw blade max.	Ø 1200 mm
Saw blade freely attachable	Ø 1200 mm
Max. cutting depth	492 mm
Dia. of saw blade arbour	Dia. 25.4 mm
Dia. of blade shaft	Dia. 45 mm left/right blade installation
Blade shaft bearing	6x high-precision ball bearings
Blade guard size	1200 mm
Blade flange diameter	Dia. 200 mm (quick release)
Blade guard weight	43 kg

## 8.10 Water

Water connection	
Parameter	Value
Pressure	min. 2 bar/max. 6 bar
Flowrate	min. 4 l/min
Max. temperature	25 °C

## 8.11 Fluids and lubricants

Fluids and lubricants		
Parameter	Value	
Engine oil	SAE 15W-40 API Class CJ-4 (11.4 litres)	
Oil for saw blade drive	ATF Synthetic SAE OW-20 (~1.9 litres)	
Oil for 3-speed transmission	SAE 75W-90 Synthetic (~2.8 litres)	
Oil for drive motor	SAE15W-40 (~1.5 litres)	
Oil for lifting pump	SAE15W-40 (~1.9 litres)	
Grease Tyrolit No. 975057	Penetration	265 to 295
	NLGI	2
Universal Spray 250 ml (sealing unit) Tyrolit No. 975061		
Radiator coolant	50/50 premixed (~11.4 litres)	

## 9 EC Declaration of Conformity

Designation	Floor saw
Type designation	FSD1274 3-speed

We declare under our sole responsibility that this product complies with the following directives and standards:

### Applicable directives

2006/42/CE	17.05.2016
2000/14/CE	08.05.2000
(EU) 2016/1628	14.09.2016 (Stage V)

### Applicable standards

EN 12100:2010  
EN 13862:2001+A1:2009

### Tyrolit Hydrostress AG

Witzbergstrasse 18  
CH-8330 Pfäffikon  
Switzerland

Pfäffikon, 09.01.2023



Roland Kägi  
Operations + R&D Machines



**TYROLIT CONSTRUCTION PRODUCTS GMBH**

Swarovskistraße 33 | 6130 Schwaz | Austria

Tel +43 5242 606-0 | Fax +43 5242 63398

Our **worldwide subsidiary companies** can be found  
on our website at **[www.tyrolit.com](http://www.tyrolit.com)**